

# COLLECTION 2024

*nelux hong kong international, ltd*



**LED LINEAR LIGHT TRACK**



**ARCHITECTURAL LIGHTING**

## LED LINEAR LIGHT COLLECTION

nelux architectural lighting

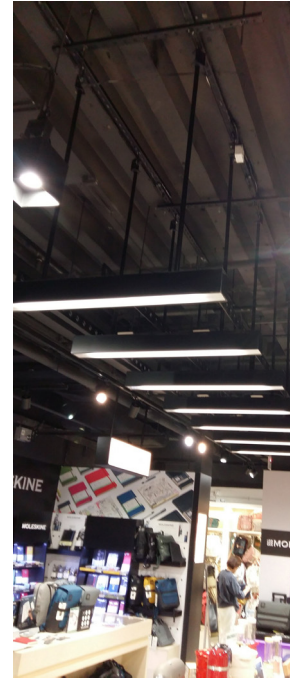

The Led Linear Track Light can be easily integrated into your projects and provide the necessary light therefore creating a pleasant atmosphere and the right illumination. Different sizes, models, and lumens available for any installation you need.

## LED LINEAR LIGHT TRACK

lighting product designers and mold management



**GENERAL FEATURES**

**Light housing** made of high quality extruded aluminum Integrated with heat sink from die-casting aluminium Advanced thermal management technology to ensure consistency of LED life span, color temperature and maximize output lumens.  
**High transmittance** PMMA diffuser creating a high visual comfort and uniform lighting distributions or black frame reflectors or black frame and lens  
**Light Source** SMD 3030 and SMD2835 led light source ~90lm/W and also available ~120lm/W CRI>80 as standard and available CRI90  
**Input voltage** Multivoltage and 220-240VAC 50/60Hz  
**Led Driver** High Standards Led driver, dimmable as an option 1-10V, Dali and white Temperature control.  
**Mounting Options** Different mounting options Track mounted, surface, recessed and suspended  
**Applications** Institutes, Hospitals, Warehouses, Hospitality Retail, Fake ceiling, concealed spaces ,ETC

**Product Image**

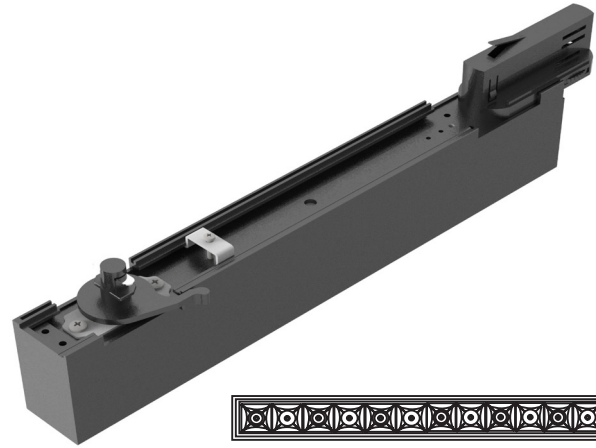

nelux CCT available correlated colour temperature

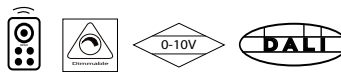

**Colour Palette**



**LLT340L**

**Diffuser lens**

Light Source SMD3030 Philips or Samsung  
 Power 15W  
 Beam Angle 10°, 24°, 38°  
 CCT 2700K 1200lm, 3000K 1300lm, 4000K 1400lm  
 Size Length 328mm, Width 37mm, Height 72mm

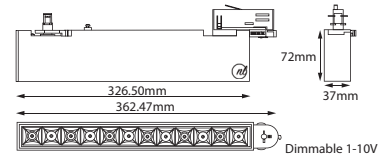
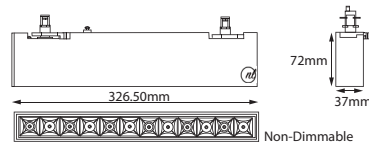

**LLT645L**

**Diffuser lens**

Light Source SMD3030 Philips or Samsung  
 Power 30W  
 Beam Angle 10°, 24°, 38°  
 CCT 2700K 2300lm, 3000K 2400lm, 4000K 2450lm  
 Size Length 646mm, Width 37mm, Height 72mm

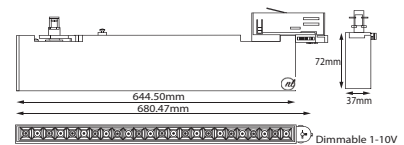
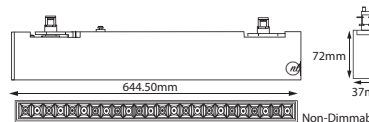

**LLT965L**

**Diffuser lens**

Light Source SMD3030 Philips or Samsung  
 Power 40W  
 Beam Angle 10°, 24°, 38°  
 CCT 2700K 3100lm, 3150K 2400lm, 4000K 3200lm  
 Size Length 962.5mm, Width 37mm, Height 72mm

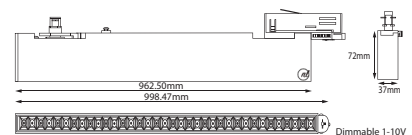
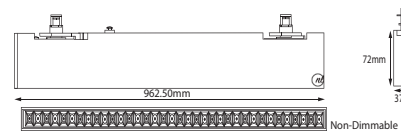

**Mounting Options**

Mountable on DIN 35 rail / Montaje en carril-riel

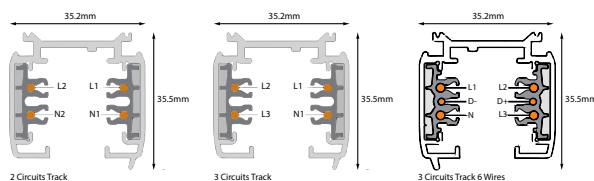

**LED LINEAR LIGHT TRACK**

lighting product designers and mold management



**GENERAL FEATURES**

**Light housing** made of high quality extruded aluminum Integrated with heat sink from die-casting aluminium Advanced thermal management technology to ensure consistency of LED life span, color temperature and maximize output lumens.

**High transmittance** PMMA diffuser creating a high visual comfort and uniform lighting distributions or black frame reflectors

**Light Source** SMD 3030 and SMD2835 led light source ~90lm/W and also available ~120lm/W CRI>80 as standard and available CRI90

**Input voltage** Multivoltage and 220-240VAC 50/60Hz

**Led Driver** High Standards Led driver, dimmable as an option 1-10V, Dali and white Temperature control.

**Mounting Options** Different mounting options Track mounted, surface, recessed and suspended

**Applications** Institutes, Hospitals, Warehouses, Hospitality Retail, Fake ceiling, concealed spaces ,ETC

**Product Image**

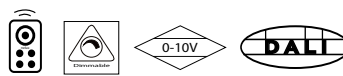
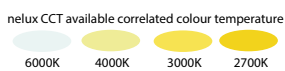
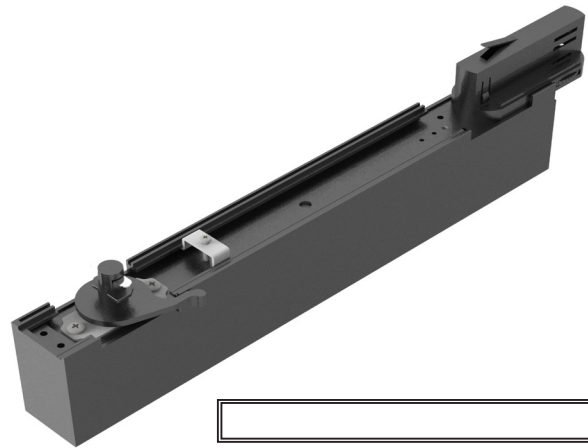

**Colour Palette**



**LLT275PC**

**Diffuser PC**

Light Source SMD2835 Philips or Samsung

Power 15W

Beam Angle 90°

CCT 2700K 1100lm, 3000K 1150lm, 4000K 1200lm

Size Length 275mm, Width 37mm, Height 72mm

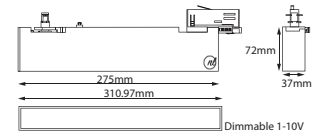
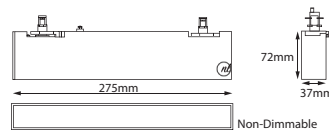

**LLT540PC**

**Diffuser PC**

Light Source SMD2835 Philips or Samsung

Power 30W

Beam Angle 90°

CCT 2700K 2200lm, 3000K 2250lm, 4000K 2300lm

Size Length 540mm, Width 37mm, Height 72mm

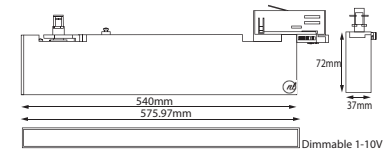
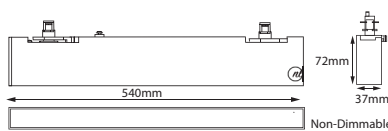

**LLT1070PC**

**Diffuser PC**

Light Source SMD2835 Philips or Samsung

Power 40W

Beam Angle 90°

CCT 2700K 3050lm, 3150K 3100lm, 4000K 3150lm

Size Length 1070mm, Width 37mm, Height 72mm

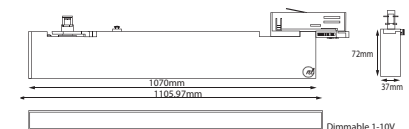
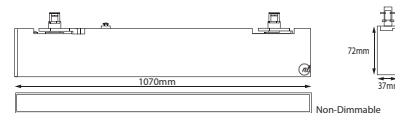

**Mounting Options**

Mountable on DIN 35 rail / Montaje en carril-riel

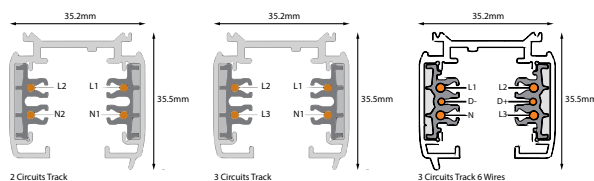

**LED LINEAR LIGHT TRACK**





**GENERAL FEATURES**

**Light housing** made of high quality extruded aluminum Integrated with heat sink from die-casting aluminium Advanced thermal management technology to ensure consistency of LED life span, color temperature and maximize output lumens.  
**High transmittance** PMMA diffuser creating a high visual comfort and uniform lighting distributions or black frame reflectors or black frame and lens  
**Light Source** SMD 3030 and SMD2835 led light source ~90lm/W and also available ~120lm/W CRI>80 as standard and available CRI90  
**Input voltage** Multivoltage and 220-240VAC 50/60Hz  
**Led Driver** High Standards Led driver, dimmable as an option 1-10V, Dali and white Temperature control.  
**Mounting Options** Different mounting options Track mounted, surface, recessed and suspended  
**Applications** Institutes, Hospitals, Warehouses, Hospitality Retail, Fake ceiling, concealed spaces ,ETC

**Product Image**

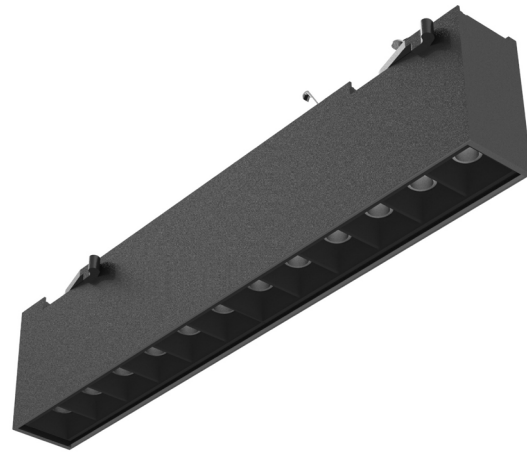

nelux CCT available correlated colour temperature



**Colour Palette**



LLT340SF\_L

**Diffuser Black frame and lens**

Light Source SMD2835 Philips or Samsung  
 Power 15W  
 Beam Angle 10°, 24°, 38°  
 CCT 2700K 1200lm, 3000K 1300lm, 4000K 1400lm  
 Size Length 328mm, Width 37mm, Height 72mm

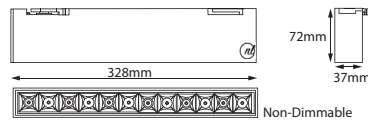

LLT646SF\_L

**Diffuser Black frame and lens**

Light Source SMD2835 Philips or Samsung  
 Power 30W  
 Beam Angle 10°, 24°, 38°  
 CCT 2700K 2300lm, 3000K 2400lm, 4000K 2450lm  
 Size Length 646mm, Width 37mm, Height 72mm



LLT965SF\_L

**Diffuser Black frame and lens**

Light Source SMD2835 Philips or Samsung  
 Power 40W  
 Beam Angle 10°, 24°, 38°  
 CCT 2700K 3100lm, 3150K 3150lm, 4000K 3200lm  
 Size Length 964mm, Width 37mm, Height 72mm

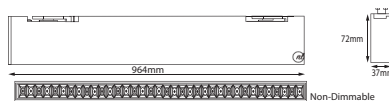

**Mounting Options**

Surface Mounted / Montaje en Superficie



**GENERAL FEATURES**

**Light housing** made of high quality extruded aluminum Integrated with heat sink from die-casting aluminium Advanced thermal management technology to ensure consistency of LED life span, color temperature and maximize output lumens.

**High transmittance** PMMA diffuser creating a high visual comfort and uniform lighting distributions or black frame reflectors

**Light Source** SMD 3030 and SMD2835 led light source ~90lm/W and also available ~120lm/W CRI>80 as standard and available CRI90

**Input voltage** Multivoltage and 220-240VAC 50/60Hz

**Led Driver** High Standards Led driver, dimmable as an option 1-10V, Dali and white Temperature control.

**Mounting Options** Different mounting options Track mounted, surface, recessed and suspended

**Applications** Institutes, Hospitals, Warehouses, Hospitality Retails, Fake ceiling, concealed spaces ,ETC

**Product Image**

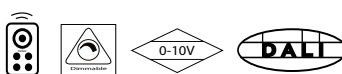
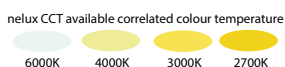
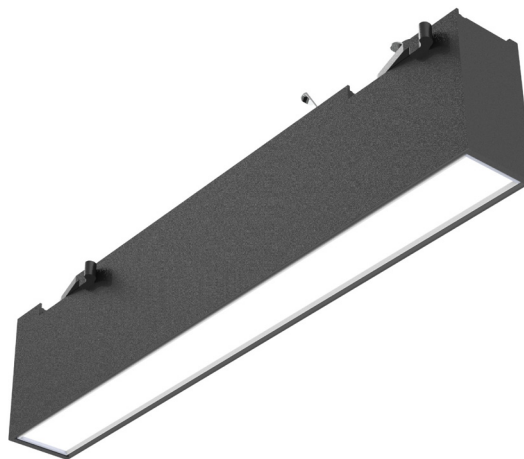

**Colour Palette**



LLT340SF\_PC

**Diffuser PC**

Light Source SMD2835 Philips or Samsung  
 Power 15W  
 Beam Angle 90°  
 CCT 2700K 1200lm, 3000K 1300lm, 4000K 1400lm  
 Size Length 328mm, Width 37mm, Height 72mm

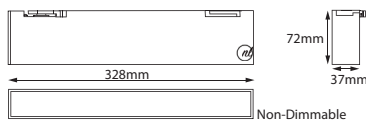

LLT646SF\_PC

**Diffuser PC**

Light Source SMD2835 Philips or Samsung  
 Power 30W  
 Beam Angle 90°  
 CCT 2700K 2300lm, 3000K 2400lm, 4000K 2450lm  
 Size Length 646mm, Width 37mm, Height 72mm

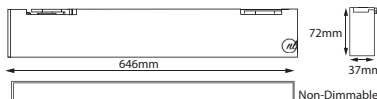

LLT965SF\_PC

**Diffuser PC**

Light Source SMD2835 Philips or Samsung  
 Power 40W  
 Beam Angle 90°  
 CCT 2700K 3100lm, 3150K 3150lm, 4000K 3200lm  
 Size Length 964mm, Width 37mm, Height 72mm

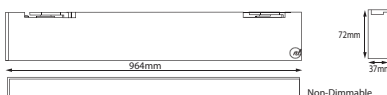

**Mounting Options**  
 Surface Mounted / Montaje en Superficie



**GENERAL FEATURES**

**Light housing** made of high quality extruded aluminum Integrated with heat sink from die-casting aluminium Advanced thermal management technology to ensure consistency of LED life span, color temperature and maximize output lumens.  
**High transmittance** PMMA diffuser creating a high visual comfort and uniform lighting distributions or black frame reflectors or black frame and lens  
**Light Source** SMD 3030 and SMD2835 led light source ~90lm/W and also available ~120lm/W CRI>80 as standard and available CRI90  
**Input voltage** Multivoltage and 220-240VAC 50/60Hz  
**Led Driver** High Standards Led driver, dimmable as an option 1-10V, Dali and white Temperature control.  
**Mounting Options** Different mounting options Track mounted, surface, recessed and suspended  
**Applications** Institutes, Hospitals, Warehouses, Hospitality Retail, Fake ceiling, concealed spaces ,ETC

**Product Image**

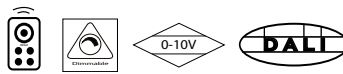
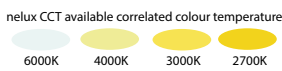
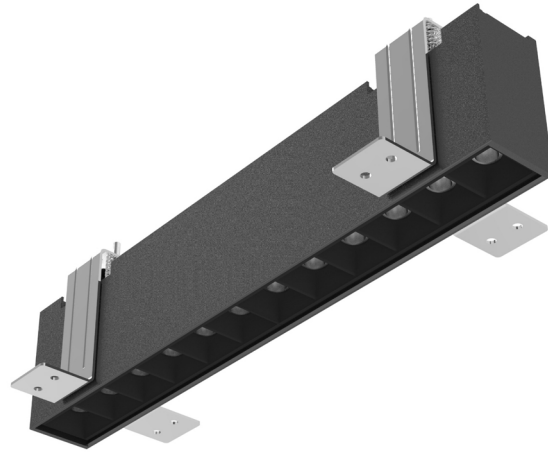

**Colour Palette**



LLT340RC\_L

**Diffuser Black frame and lens**

Light Source SMD2835 Philips or Samsung  
 Power 15W  
 Beam Angle 10°, 24°, 38°  
 CCT 2700K 1200lm, 3000K 1300lm, 4000K 1400lm  
 Size Length 328mm, Width 37mm, Height 72mm

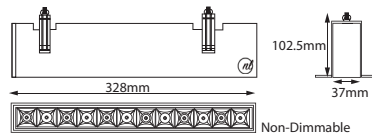

LLT646RC\_L

**Diffuser Black frame and lens**

Light Source SMD2835 Philips or Samsung  
 Power 30W  
 Beam Angle 10°, 24°, 38°  
 CCT 2700K 2300lm, 3000K 2400lm, 4000K 2450lm  
 Size Length 646mm, Width 37mm, Height 72mm

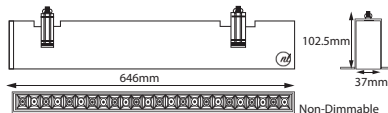

LLT965RC\_L

**Diffuser Black frame and lens**

Light Source SMD2835 Philips or Samsung  
 Power 40W  
 Beam Angle 10°, 24°, 38°  
 CCT 2700K 3100lm, 3150K 3150lm, 4000K 3200lm  
 Size Length 964mm, Width 37mm, Height 72mm

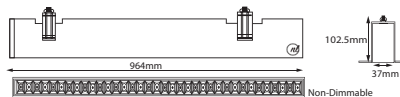

**Mounting Options**

Recessed Mounted / Montaje empotrado en techo





**Product Image**

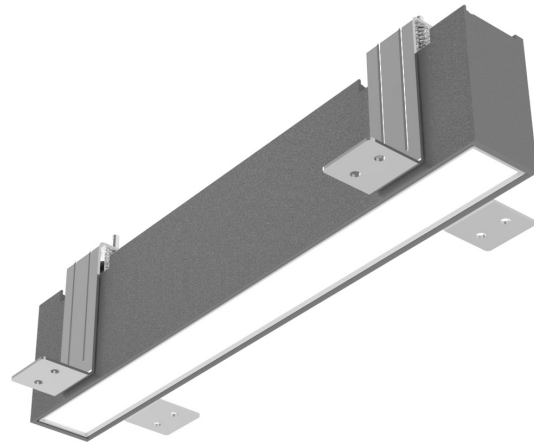

**GENERAL FEATURES**

**Light housing** made of high quality extruded aluminum Integrated with heat sink from die-casting aluminium Advanced thermal management technology to ensure consistency of LED life span, color temperature and maximize output lumens.  
**High transmittance** PMMA diffuser creating a high visual comfort and uniform lighting distributions or black frame reflectors  
**Light Source** SMD 3030 and SMD2835 led light source ~90lm/W and also available ~120lm/W CRI>80 as standard and available CRI90  
**Input voltage** Multivoltage and 220-240VAC 50/60Hz  
**Led Driver** High Standards Led driver, dimmable as an option 1-10V, Dali and white Temperature control.  
**Mounting Options** Different mounting options Track mounted, surface, recessed and suspended  
**Applications** Institutes, Hospitals, Warehouses, Hospitality Retails, Fake ceiling, concealed spaces ,ETC

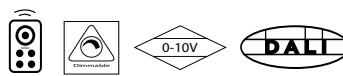
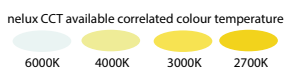

**Colour Palette**



LLT340RC\_PC

**Diffuser PC**

Light Source SMD2835 Philips or Samsung  
 Power 15W  
 Beam Angle 90°  
 CCT 2700K 1100lm, 3000K 1150lm, 4000K 1200lm  
 Size Length 328mm, Width 37mm, Height 72mm

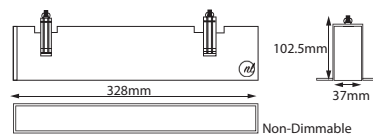

LLT646RC\_PC

**Diffuser PC**

Light Source SMD2835 Philips or Samsung  
 Power 30W  
 Beam Angle 90°  
 CCT 2700K 2200lm, 3000K 2250lm, 4000K 2300lm  
 Size Length 646mm, Width 37mm, Height 72mm

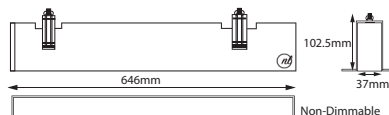

LLT965RC\_PC

**Diffuser PC**

Light Source SMD2835 Philips or Samsung  
 Power 40W  
 Beam Angle 90°  
 CCT 2700K 3050lm, 3000K 3100lm, 4000K 3150lm  
 Size Length 964mm, Width 37mm, Height 72mm

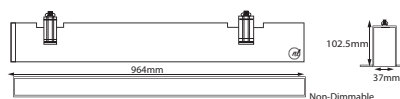

**Mounting Options**

Recessed Mounted / Montaje empotrado en techo





**GENERAL FEATURES**

**Light housing** made of high quality extruded aluminum Integrated with heat sink from die-casting aluminium Advanced thermal management technology to ensure consistency of LED life span, color temperature and maximize output lumens.  
**High transmittance** PMMA diffuser creating a high visual comfort and uniform lighting distributions or black frame reflectors or black frame and lens  
**Light Source** SMD 3030 and SMD2835 led light source ~90lm/W and also available ~120lm/W CRI>80 as standard and available CRI90  
**Input voltage** Multivoltage and 220-240VAC 50/60Hz  
**Led Driver** High Standards Led driver, dimmable as an option 1-10V, Dali and white Temperature control.  
**Mounting Options** Different mounting options Track mounted, surface, recessed and suspended  
**Applications** Institutes, Hospitals, Warehouses, Hospitality Retail, Fake ceiling, concealed spaces ,ETC

**Product Image**

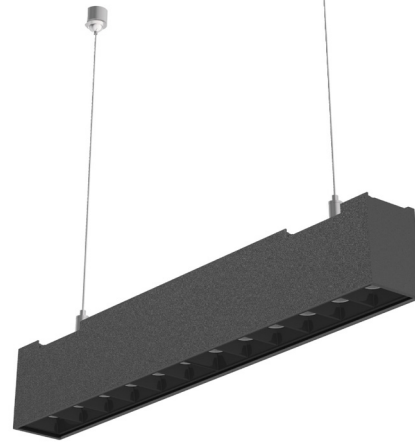

nelux CCT available correlated colour temperature

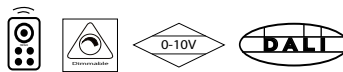

**Colour Palette**



**LLT340PD\_L**

**Diffuser Black Frame and Lens**

Light Source SMD2835 Lumileds, Samsung  
 Power 15W  
 Beam Angle 10°, 24°, 38°  
 CCT 2700K-1200lm, 3000K-1300lm, 4000K-1400lm  
 Size L328\*W37\*H73mm

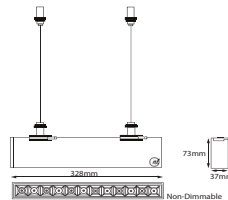

**LLT645PD\_L**

**Diffuser Black Frame and Lens**

Light Source SMD2835 Lumileds, Samsung  
 Power 30W  
 Beam Angle 10°, 24°, 38°  
 CCT 2700K-2300lm, 3000K-2400lm, 4000K-2450lm  
 Size L646\*W37\*H73mm

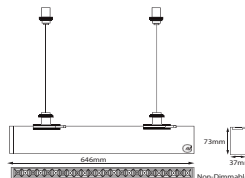

**LLT965PD\_L**

**Diffuser Black Frame and Lens**

Light Source SMD2835 Lumileds, Samsung  
 Power 40W  
 Beam Angle 10°, 24°, 38°  
 CCT 2700K-3100lm, 3000K-3150lm, 4000K-3200lm  
 Size L964\*W37\*H73mm

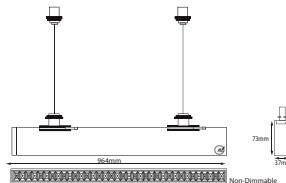

**Mounting Options**

Pendant mounted / Montaje suspendido



## GENERAL FEATURES

**Light housing** made of high quality extruded aluminum Integrated with heat sink from die-casting aluminium Advanced thermal management technology to ensure consistency of LED life span, color temperature and maximize output lumens.

**High transmittance** PMMA diffuser creating a high visual comfort and uniform lighting distributions or black frame reflectors

**Light Source** SMD 3030 and SMD2835 led light source ~90lm/W and also available ~120lm/W CRI>80 as standard and available CRI90

**Input voltage** Multivoltage and 220-240VAC 50/60Hz

**Led Driver** High Standards Led driver, dimmable as an option 1-10V, Dali and white Temperature control.

**Mounting Options** Different mounting options Track mounted, surface, recessed and suspended

**Applications** Institutes, Hospitals, Warehouses, Hospitality Retail, Fake ceiling, concealed spaces ,ETC

## Product Image

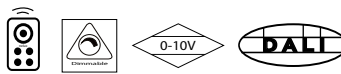
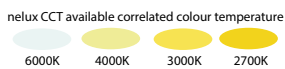
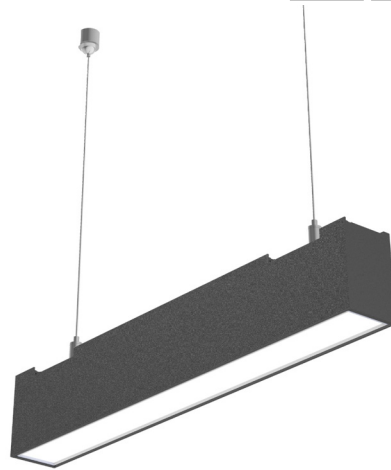

## Colour Palette



LLT340PD\_PC

### Diffuser PC

Light Source SMD2835 Philips or Samsung

Power 15W

Beam Angle 90°

CCT 2700K 1100lm, 3000K 1150lm, 4000K 1200lm

Size Length 328mm, Width 37mm, Height 73mm

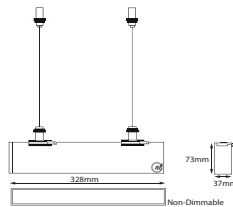

LLT645PD\_PC

### Diffuser PC

Light Source SMD2835 Philips or Samsung

Power 30W

Beam Angle 90°

CCT 2700K 2200lm, 3000K 2250lm, 4000K 2300lm

Size Length 646mm, Width 37mm, Height 73mm

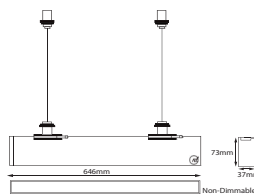

LLT965PD\_PC

### Diffuser PC

Light Source SMD2835 Philips or Samsung

Power 40W

Beam Angle 90°

CCT 2700K 3050lm, 3150K 3100lm, 4000K 3150lm

Size Length 964mm, Width 37mm, Height 73mm

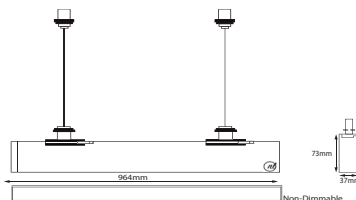

## Mounting Options

Pendant mounted / Montaje suspendido