

COLLECTION 2020-2024

nelux hong kong international, ltd



**COMMERCIAL & RESIDENTIAL
TRACK SPOT LIGHT**



ARCHITECTURAL LIGHTING

TRACK SPOT LIGHT

**hotel
shops
home
office
cafe....**

nelux (HK) international, ltd



PROFILE

Nelux Hong Kong International, Ltd located in Tuen Mun Industrial area in Hong Kong, with a convenient location in Asia to export all over the world.

Since founded in 2010, we have been focusing on designing, and producing architectural lighting products. We work with first-class led technology and craft, working with the best equipment in the market providing high quality products and good service to our customers.

QUALITY

Nelux is committed to the developing, production and distribution of led lighting products with the best quality in accessories, assembling and finishing products. At present to determine the quality of our products we have mastered the leading core technology, which makes our products reach the international advance levels. Main and basic parameters in our led lights: Chips, Optical, Reflectors, and Thermal Management.

Chips, using the top brands in the market we can achieve the best quality of our products. Optical, the suitable reflectors or lens is a fundamental part of our products, making the illuminated objects get their right texture and value.

Reflectors, nelux install the precision reflectors for each model, to make beam angle accurate, and getting a uniformity in lighting distribution. Working with spot, medium and flood beam angle with a wide range of degrees according to customer needs.

Thermal Management, not only the life of the light source is decided but its own quality, but also affects the lighting fixture quality. The life of LED is related to Nelux Hong Kong International, Ltd located in Tuen Mun Industrial area in Hong Kong, with a convenient location in Asia to export all over the world.

ABOUT US

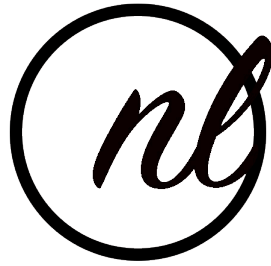

The Nelux Hong Kong International, Ltd is a design, research, development, distribution, production, sales and service company in one of the integrated Smart Home and LED lighting enterprises.

Nelux architectural lighting, since the establishment of the company, maintains a high-speed growth, and gradually becomes the leading enterprise in the LED lighting industry. In Hong Kong, Nelux architectural lighting has two bases our head office in Wanchai and our assembling workhouse in Tuen Mun.

In the worldwide, 95% of our products to the export, sold to over 15 countries around world. We also sets up a wide range of agents, marketing, after-sales networks across the world. Such as Europe, South America, The Middle East, and Hong Kong.

Through the years cautious and conscientious work, our linear products and lighting project has built a great reputation in the customer's local markets.

The different LED series we introduce in this catalog is not only the realization of the traditional energy-saving lighting, but also it embodies the concept of innovation, unique design style and customer exclusive customization. Once introduced, it has been unanimously praised and trusted by the users at home and abroad.

Rely on many years of unremitting efforts, continuous development, based on advanced management mechanism, strong R & D strength, complete marketing network and sound service system. Our products and One-stop overall lighting customized solutions (scheme design + customization products +

intelligent control system + installation service) are the first choice of many illuminating Engineering contractors and lighting interior design companies.

Our products are widely used in high-grade hotels, high-end commercial real estate, office, industrial and numerous of civilian areas. fully meet the market demand of high-end lighting. Finally in September 2018, our company show up in the lead trend of the industry development and launch new products you can see in this new catalog. This series highlights the simplicity, fashion, beautiful design style, elaborates the perfect combination of light and beauty once again.

All the time always stuck to business philosophy of "Adherence to Commitment, Prompt and High efficient, Harmony and Mutual win". The company's brand concept of "Creating value for you" also has been deeply rooted in our client's mind.

We always adhere to the values of focusing on customer's demands, sincerity-oriented, and trust-based. Humanistic management is our mile stone of enterprise development.

We are focus on every product, every lighting project, and strive to provide competitive products, services and high effective one-stop-shop solutions for the enterprise customers and consumers.

Thank you for your continued support! Welcome to contact us!

Nelux Hong Kong International, Ltd

ARCHITECTURAL LIGHTING

LED LINEAR LIGHT COLLECTION	
LED LINEAR LIGHT PROFILES	PAGES.....6-38
LED LINEAR LIGHT TRACKS	PAGES.....39-47
LED TRACK SPOT LIGHT	PAGES.....48-58
MINI SPOTLIGHT	PAGES.....59-62
MINI COMBI AND COMBI	PAGES.....63-67
DECORATIVE LAMPS	PAGES.....68-74
CEILING SURFACE	PAGES.....75-83
BED LIGHT	PAGES.....84-89
SHOWCASE ILLUMINATION	PAGES.....90-94
CEILING RECESSED	PAGES.....95-98
DOWNLIGHT	PAGES.....99-104
SPOT LIGHT	PAGES.....105-113
WALL WASJER DOWNLIGHT	PAGES.....114-116
INLINE	PAGES.....117-121
IP54 AND IP65 DOWNLIGHT	PAGES.....122-126
GRILLE LIGHT / CARDAN	PAGES.....127-131

COMMERCIAL AND RESIDENTIAL OUTDOOR LIGHTING

INGROUND	PAGES.....132-141
WALL RECESSED	PAGES.....142-147
LED PROJECTOR	PAGES.....148-154
SPIKE SPOTLIGHT	PAGES.....155-165

LED TRACK SPOT LIGHT

nelux architectural lighting

Our track spotlights are made from Aluminium Die-casting, electrostatic powder coating. Gear box are made from aluminium or aluminium Die-casting.
 Reflectors made from Aluminium anodized specular silver.
 Brand of Chip CREE and other brands like Citizen and Bridgelux available,



TS81107 SMD 9W, 15W
TS81107 COB 20W



TS98107 SMD 18W, 30W
TS98107 COB 30W



TS70145 18W
TS85160 25W
TS95170 33W



TS85104 18W
TS95112 25W
TS106123 33W



TS6075 4W, 8W



TS5389 GU10



TS20139 15W



TS65105 15W
TS75145 25W
TS85165 35W
TS95195 45W



TS65185 30W



TS825910W
TS10172 20W



TS85104R 20W, 28W



TS85104L 20W, 28W



TS95112 28W, 35W



TS95112L 28W, 35W



TS106123 28W, 35W



TS106123 L 28W, 35W



TS115104 28W, 35W



TS125125 28W, 35W

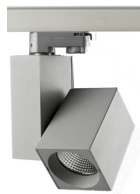

TS8585 28W
TS9595 35W



TS8585 28W
TS9595 35W



TS95100 11W



TS6090 11W



TS95100 16W



TS95112 25W



TS95133 32W



TS111155 11W



TS300110 20W



TS81107

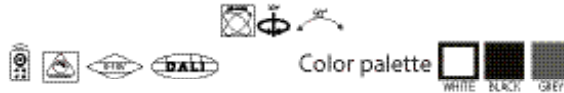
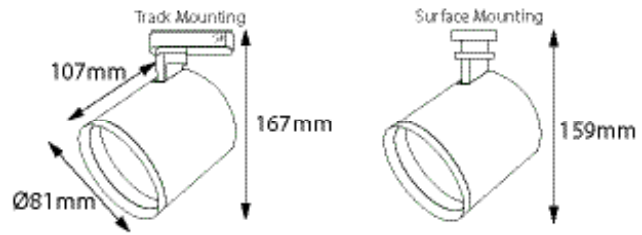

TS81107 Track Spotlight and Surface Mounting

Input Voltage 220-240VAC Multivoltage / 50-60Hz
 Light Power SMD 9W/15W, COB 20W
 Luminous flux ~630lm/1050lm, ~1400lm
 Light Source SMD or COB
 CCT 3000K, 4000K
 CRI >80 CRI90, CRI97 as an option
 Diffuser Lens
 Beam Angle Reflector Extra wide flood, Oval flood,
 Rectangle flood, Wall washer flood
 Driver Built-in
 Operating Temperature -25°C~+50°



TS98107 Track Spotlight and Surface Mounting

Input Voltage 220-240VAC Multivoltage / 50-60Hz
 Light Power SMD 18W/30W, COB 30W
 Luminous flux ~1260lm/2100lm, ~2100lm
 Light Source SMD or COB
 CCT 3000K, 4000K
 CRI >80 CRI90, CRI97 as an option
 Diffuser Lens
 Beam Angle Reflector Extra wide flood, Oval flood,
 Rectangle flood, Wall washer flood
 Driver Built-in
 Operating Temperature -25°C~+50°

TS98107

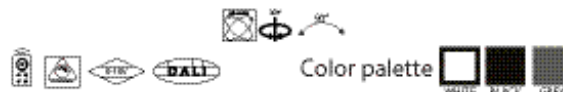
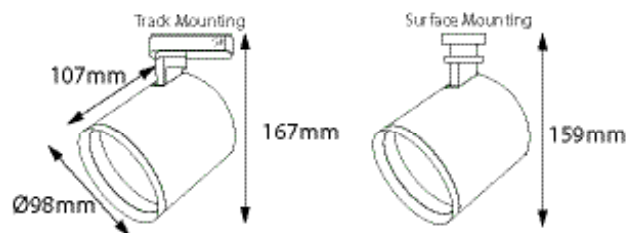

ZOE SERIES

LED TRACK SPOT LIGHT

nelux architectural lighting



TS70145 Track Spotlight

Input Voltage AC220-240V, Multivoltage
 Light Power 18W
 Luminous flux ~1755lm
 Light Source CREE
 CCT 3000K, 4000K
 CRI 80 as standard, CRI90, 95, 97
 Beam Angle Reflector 15°, 30°, 45°
 Driver, Khun, Xz, Philips other options available
 Dimmable 0-10V, Triac, Dali as an option

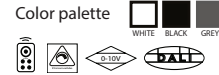
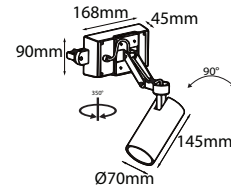

TS85160 Track Spotlight

Input Voltage AC220-240V, Multivoltage
 Light Power 25W
 Luminous flux ~2410lm
 Light Source CREE
 CCT 3000K, 4000K
 CRI 80 as standard, CRI90, 95, 97
 Beam Angle Reflector 15°, 30°, 45°
 Driver, Khun, Xz, Philips other options available
 Dimmable 0-10V, Triac, Dali as an option

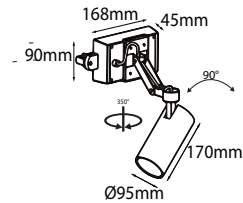
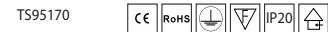
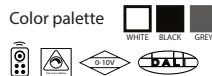
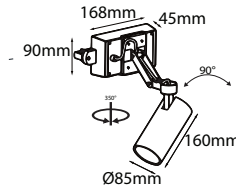

TS95170 Track Spotlight

Input Voltage AC220-240V, Multivoltage
 Light Power 33W
 Luminous flux ~3490lm
 Light Source CREE
 CCT 3000K, 4000K
 CRI 80 as standard, CRI90, 95, 97
 Beam Angle Reflector 15°, 30°, 45°
 Driver, Khun, Xz, Philips other options available
 Dimmable 0-10V, Triac, Dali as an option



TS85104 Track Spotlight

Input Voltage AC220-240V, Multivoltage
 Light Power 18W
 Luminous flux ~1755lm
 Light Source CREE
 CCT 3000K, 4000K
 CRI 80 as standard, CRI90, 95, 97
 Beam Angle Reflector 12°, 24°, 45°, 55°
 Driver, Khun, Xz, Philips other options available
 Dimmable 0-10V, Triac, Dali as an option

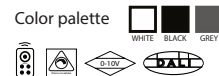
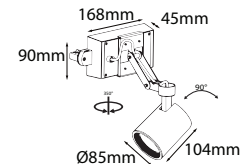

TS95112 Track Spotlight

Input Voltage AC220-240V, Multivoltage
 Light Power 25W
 Luminous flux ~2610lm
 Light Source CREE
 CCT 3000K, 4000K
 CRI 80 as standard, CRI90, 95, 97
 Beam Angle Reflector 15°, 30°, 40°, 55°
 Driver, Khun, Xz, Philips other options available
 Dimmable 0-10V, Triac, Dali as an option

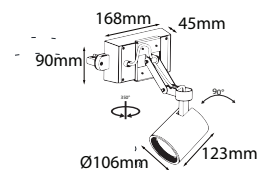
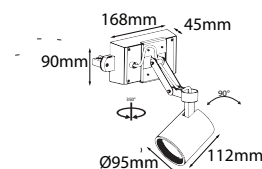

TS106123 Track Spotlight

Input Voltage AC220-240V, Multivoltage
 Light Power 33W
 Luminous flux ~3490lm
 Light Source CREE
 CCT 3000K, 4000K
 CRI 80 as standard, CRI90, 95, 97
 Beam Angle Reflector 12°, 30°, 45°, 60°
 Driver, Khun, Xz, Philips other options available
 Dimmable 0-10V, Triac, Dali as an option

FOSO SERIES

LED TRACK SPOT LIGHT



TS6075 Track Spotlight

Input Voltage 110-240VAC, 220-240VAC / 50-60Hz
 Light Power 4W, 8W
 Luminous flux >80lm/W PMMA Lens
 Light Source AC COB Seoul semiconductor
 CCT 2700K, 3000K, 4000K
 CRI >80
 Beam Angle Reflector 24°, 37°
 Driver PF0.9 Uout 36DVC Iout 200mA
 Operating Temperature -25°C~+50°



TS6075

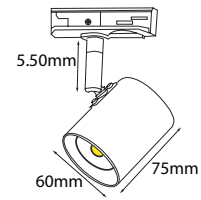

Color palette
 WHITE BLACK GREY



TS5389



Color palette
 WHITE BLACK GREY

Model COSI TS5389

Input Voltage 110-240VAC, 220-240VAC / 50-60Hz
 Power Max 7W GU10
 Light Source led Lamp GU10
 Beam angle depending on lamp GU10 °
 CCT 3000K, 4000K, 5000K
 Light Efficiency lm depending on lamp GU10
 CRI >80
 Operating Temperature -25°C~+50°C

COSI SERIES



TS20139 Track Spotlight 3 phase Track

Input Voltage 220-240VAC Multivoltage / 50-60Hz
 Light Power 15W
 Luminous flux ~900lm
 Light Source 6pcs OSRAM SMD
 CCT 3000K, 4000K
 CRI >80 CRI>90
Diffuser Spot, Flood, Wide flood and oval, rectangle, wallwasher
 Beam Angle Reflector 15°, 24°, 36°
 Driver Built-in
 Operating Temperature -25°C~+50°

TS20139

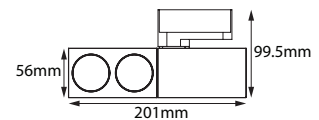

Color palette
 WHITE BLACK GREY



BELLA SERIES

LED TRACK SPOT LIGHT

TS65105 Track Spotlight

Input Voltage 220-240VAC Multivoltage / 50-60Hz
 Light Power 15W
 Luminous flux ~1350lm
 Light Source COB Citizen
 CCT 2700K, 3000K, 4000K
 CRI >80
 Diffuser Lens+Reflector
 Beam Angle Reflector 15°, 24°, 38°
 Driver Built-in
 Operating Temperature -25°C~+50°

TS65105

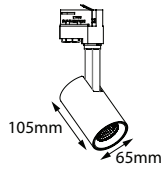

TS75145 Track Spotlight

Input Voltage 220-240VAC Multivoltage / 50-60Hz
 Light Power 25W
 Luminous flux ~2250lm
 Light Source COB Citizen
 CCT 2700K, 3000K, 4000K
 CRI >80
 Diffuser Lens+Reflector
 Beam Angle Reflector 15°, 24°, 38°
 Driver Built-in
 Operating Temperature -25°C~+50°

TS75145

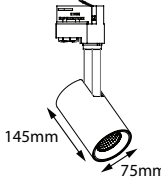

TS85165 Track Spotlight

Input Voltage 220-240VAC Multivoltage / 50-60Hz
 Light Power 35W
 Luminous flux ~3150lm
 Light Source COB Citizen
 CCT 2700K, 3000K, 4000K
 CRI >80 CRI90, CRI97 as an option
 Diffuser Lens+Reflector
 Beam Angle Reflector 15°, 24°, 38°
 Driver Built-in
 Operating Temperature -25°C~+50°

TS85165

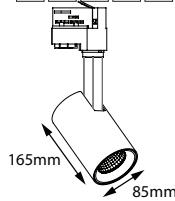

TS95195 Track Spotlight

Input Voltage 220-240VAC Multivoltage / 50-60Hz
 Light Power 45W
 Luminous flux ~4050lm
 Light Source COB Citizen
 CCT 2700K, 3000K, 4000K
 CRI >80 CRI90, CRI97 as an option
 Diffuser Lens+Reflector
 Beam Angle Reflector 15°, 24°, 38°
 Driver Built-in
 Operating Temperature -25°C~+50°

TS95195

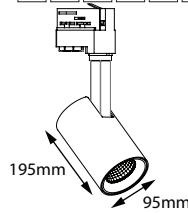

TS65185 Track Spotlight

Input Voltage 220-240VAC Multivoltage / 50-60Hz
 Light Power 30W
 Luminous flux ~2450lm
 Light Source Khun COB
 CCT 2700K, 3000K, 4000K
 CRI >80 CRI90, CRI97 as an option
 Diffuser Lens+Reflector
 Beam Angle Reflector 15°, 24°, 36°
 Driver Built-in XZ KHUN non-dimmable
 Operating Temperature -25°C~+50°

TS65185

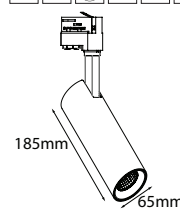

HOFF SERIES



TS8259 Track Spotlight

Input Voltage 220-240VAC Multivoltage / 50-60Hz
 Light Power 10W
 Luminous flux ~900lm
 Light Source COB Citizen
 CCT 2700K, 3000K, 4000K
 CRI >80 CRI90, CRI97 as an option
 Diffuser Lens+Reflector
 Beam Angle Reflector 15°, 24°, 36°
 Driver Built-in
 Operating Temperature -25°C~+50°

TS8259

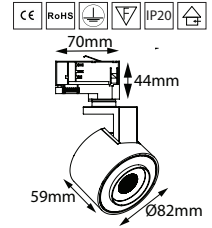

Color palette



TS10172

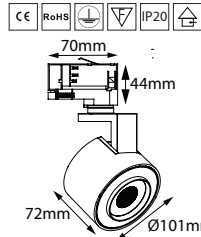

Color palette

TS10172 Track Spotlight

Input Voltage 220-240VAC Multivoltage / 50-60Hz
 Light Power 20W
 Luminous flux ~1800lm
 Light Source COB Citizen
 CCT 2700K, 3000K, 4000K
 CRI >80 CRI90, CRI97 as an option
 Diffuser Lens+Reflector
 Beam Angle Reflector 15°, 24°, 36°
 Driver Built-in
 Operating Temperature -25°C~+50°



Track Spot light, series Hoff reference TS85165 35W, ~3150lm

CIRCLE SERIES

LED TRACK SPOT LIGHT

nelux architectural lighting

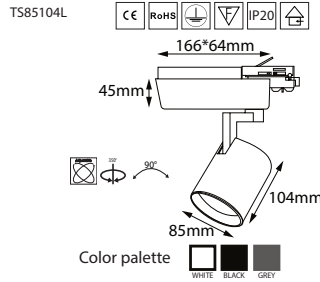

Model LINO TS85104R

Input Voltage 110-240VAC, 220-240VAC /50-60Hz
 Power 20W, **28W**
 Light Source led Lamp Led COB Cree
 Beam angle 12°, 24°, 45°, 55°
 CCT 3000K, 4000K, 5000K
 Light Efficiency ~1800lm, ~**2500lm**
 CRI >85 CRI >90.
 Gear box driver, Philips, HEP
 Operating Temperature -25°C~+50°C
 High efficiency led lens, luminous efficiency >91%
 Accessories Barndoors, anti-glare ring, honey comb



Model LINO TS85104L

Input Voltage 110-240VAC, 220-240VAC /50-60Hz
 Power 20W, **28W**
 Light Source led Lamp Led COB Cree
 Beam angle 12°, 25°, 36°
 CCT 3000K, 4000K, 5000K
 Light Efficiency ~1800lm, ~**2500lm**
 CRI >85 CRI >90.
 Gear box driver, Philips, HEP
 Operating Temperature -25°C~+50°C
 High efficiency led lens, luminous efficiency >91%
 Accessories Barndoors, anti-glare ring, honey comb

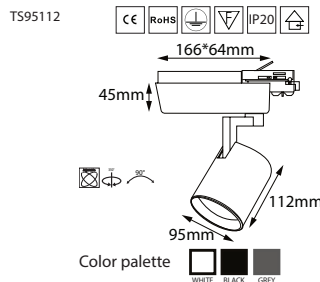
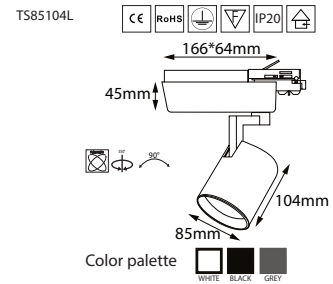

Model LINO TS95112

Input Voltage 110-240VAC, 220-240VAC /50-60Hz
 Power 28W, **35W**
 Light Source led Lamp Led COB Cree
 Beam angle 20°, 24°, 30°, 40°, 55°
 CCT 3000K, 4000K, 5000K
 Light Efficiency ~2380lm, ~**3000lm**
 CRI >85 CRI >90.
 Gear box driver, Philips, HEP
 Operating Temperature -25°C~+50°C
 High efficiency led lens, luminous efficiency >91%
 Accessories Barndoors, anti-glare ring, honey comb



Model LINO TS95112L

Input Voltage 110-240VAC, 220-240VAC /50-60Hz
 Power 28W, **35W**
 Light Source led Lamp Led COB Cree
 Beam angle 15°, 24°, 36°
 CCT 3000K, 4000K, 5000K
 Light Efficiency ~2700lm, ~**3300lm**
 CRI >85 CRI >90.
 Gear box driver, Philips, HEP
 Operating Temperature -25°C~+50°C
 High efficiency led lens, luminous efficiency >91%
 Accessories Barndoors, anti-glare ring, honey comb

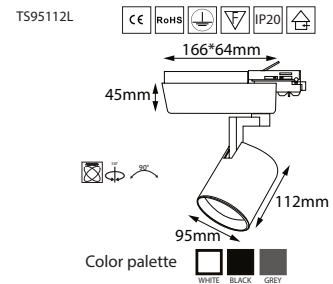

LINO SERIES

LED TRACK SPOT LIGHT

nelux architectural lighting

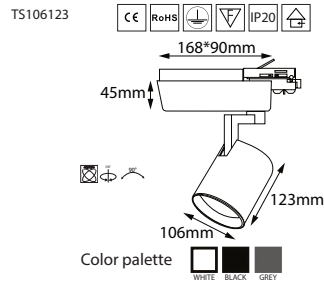

Model LINO TS106123

Input Voltage 110-240VAC, 220-240VAC /50-60Hz
 Power 28W, **35W**
 Light Source led Lamp Led COB Cree
 Beam angle 15°, 30°, 45°, 60°
 CCT 3000K, 4000K, 5000K
 Light Efficiency ~2350lm, ~**3100lm**
 CRI >85 CRI>90.
 Gear box driver, Philips, HEP
 Operating Temperature -25°C~+50°C
 High efficiency led lens, luminous efficiency >91%
 Accessories Barndoors, anti-glare ring, honey comb



Model LINO TS106123L

Input Voltage 110-240VAC, 220-240VAC /50-60Hz
 Power 28W, **35W**
 Light Source led Lamp Led COB Cree
 Beam angle 12°, 24°, 36°
 CCT 3000K, 4000K, 5000K
 Light Efficiency ~2650lm, ~**3300lm**
 CRI >85 CRI>90.
 Gear box driver, Philips, HEP
 Operating Temperature -25°C~+50°C
 High efficiency led lens, luminous efficiency >91%
 Accessories Barndoors, anti-glare ring, honey comb

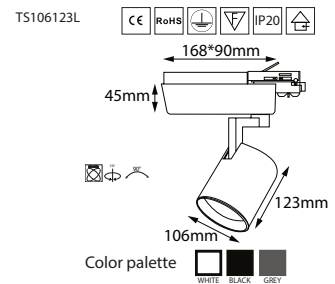

LINO SERIES

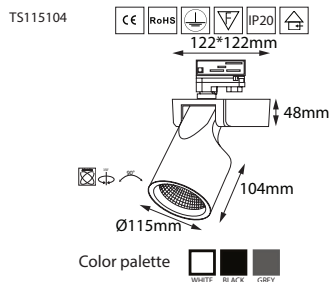

Model ROME TS115104

Input Voltage 110-240VAC, 220-240VAC /50-60Hz
 Power 28W, **35W**
 Light Source led Lamp Led COB Cree
 Beam angle 15°, 30°, 45°, 60°
 CCT 3000K, 4000K, 5000K
 Light Efficiency ~2400lm, ~**3200lm**
 CRI >85 CRI>90.
 Gear box driver, Philips, HEP
 Operating Temperature -25°C~+50°C
 High efficiency led lens, luminous efficiency >91%
 Accessories Barndoors, anti-glare ring, honey comb



ROME SERIES



Model BEACON TS125125

Input Voltage 110-240VAC, 220-240VAC /50-60Hz
 Power 28W, **35W**
 Light Source led Lamp Led COB Cree
 Beam angle 12°, 24°, 36°
 CCT 3000K, 4000K, 5000K
 Light Efficiency ~2500lm, ~**3200lm**
 CRI >85 CRI>90.
 Gear box driver, Philips, HEP
 Operating Temperature -25°C~+50°C
 High efficiency led lens, luminous efficiency >91%
 Accessories Barndoors, anti-glare ring, honey comb

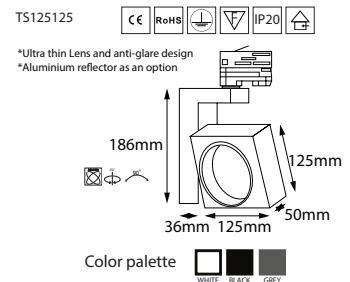

BEACON SERIES

LED TRACK SPOT LIGHT

nelux architectural lighting

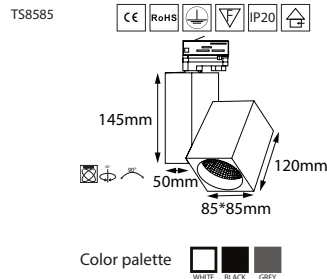
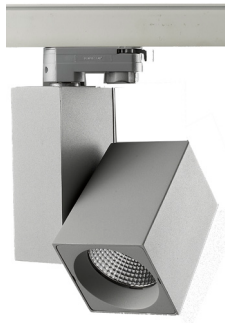

Model TRIX TS8585

Input Voltage 110-240VAC, 220-240VAC /50-60Hz
 Power 28W
 Light Source led Lamp Led COB Cree
 Beam angle 12°, 24°, 36°
 CCT 3000K,4000K, 5000K
 Light Efficiency ~2450lm
 CRI >85 CRI>90.
 Gear box driver, Philips, HEP
 Operating Temperature -25°C~+50°C
 High efficiency AL.Anodized Specular Silver Reflector

Model TRIX TS9595

Input Voltage 110-240VAC, 220-240VAC /50-60Hz
 Power 35W
 Light Source led Lamp Led COB Cree
 Beam angle 12°, 24°, 36°
 CCT 3000K,4000K, 5000K
 Light Efficiency ~3100lm
 CRI >85 CRI>90.
 Gear box driver, Philips, HEP
 Operating Temperature -25°C~+50°C
 High efficiency AL.Anodized Specular Silver Reflector

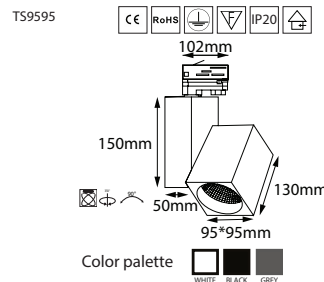

TRIX SERIES

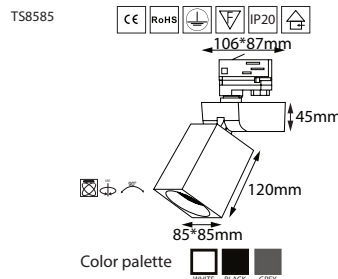

Model VENICE TS8585

Input Voltage 110-240VAC, 220-240VAC /50-60Hz
 Power 28W
 Light Source led Lamp Led COB Cree
 Beam angle 15°, 30°, 45°, 55°
 CCT 3000K,4000K, 5000K
 Light Efficiency ~2450lm
 CRI >85 CRI>90.
 Gear box driver, Philips, HEP
 Operating Temperature -25°C~+50°C
 High efficiency AL.Anodized Specular Silver Reflector

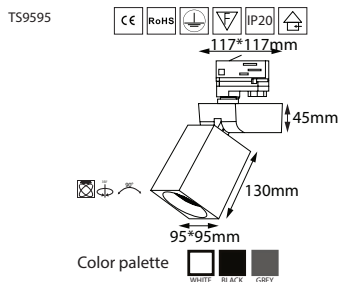

Model VENICE TS9595

Input Voltage 110-240VAC, 220-240VAC /50-60Hz
 Power 35W
 Light Source led Lamp Led COB Cree
 Beam angle 20°, 24°, 30°, 40°, 55°
 CCT 3000K,4000K, 5000K
 Light Efficiency ~3100lm
 CRI >85 CRI>90.
 Gear box driver, Philips, HEP
 Operating Temperature -25°C~+50°C
 High efficiency AL.Anodized Specular Silver Reflector



VENICE SERIES

LED TRACK SPOT LIGHT



TS95100 Track Spotlight

Input Voltage 220-240VAC Multivoltage / 50-60Hz
 Light Power 11W
 Luminous flux ~900lm
 Light Source CREE COB
 CCT 2700K, 3000K, 4000K, 5000K
 CRI >80 CRI>90
 Optical components lens, ring color or honey-comb as an option
 Beam Angle Reflector 18°, 24°, 36°, 60°
 Driver Built-in constant current
 Operating Temperature -25°C~+50°

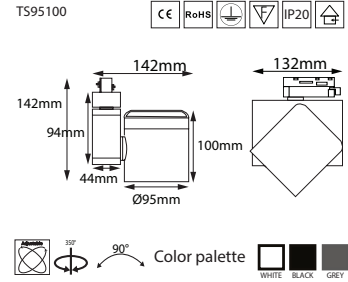

TS6090

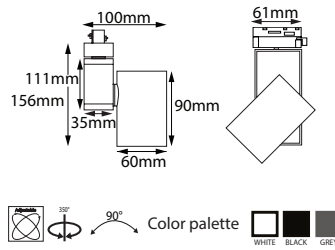

TS6090 Track Spotlight

Input Voltage 220-240VAC Multivoltage / 50-60Hz
 Light Power 11W
 Luminous flux ~900lm
 Light Source CREE COB
 CCT 2700K, 3000K, 4000K, 5000K
 CRI >80 CRI>90
 Optical components, lens, ring color or honey-comb as an option
 Beam Angle Reflector 18°, 24°, 36°, 60°
 Driver Built-in constant current DC300mA
 Operating Temperature -25°C~+50°

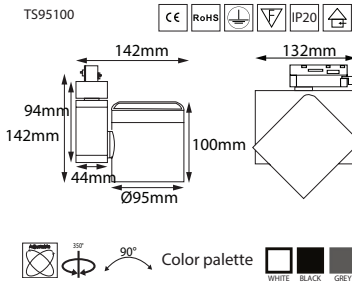

TS95100 Track Spotlight

Input Voltage 220-240VAC Multivoltage / 50-60Hz
 Light Power 16W
 Luminous flux ~1350lm
 Light Source CREE COB
 CCT 2700K, 3000K, 4000K, 5000K
 CRI >80 CRI>90
 Optical components Lens and honey comb
 Beam Angle Reflector 12°, 24°, 36°
 Driver Built-in constant current DC450mA
 Operating Temperature -25°C~+50°



TS95112

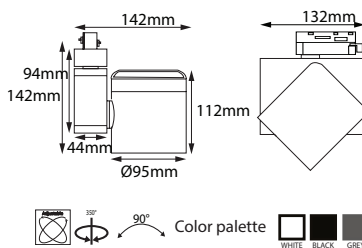

TS95112 Track Spotlight

Input Voltage 220-240VAC Multivoltage / 50-60Hz
 Light Power 25W
 Luminous flux ~2200lm
 Light Source CREE COB
 CCT 2700K, 3000K, 4000K, 5000K
 CRI >80 CRI>90
 Optical components Lens and honey comb
 Beam Angle Reflector 15°, 24°, 36°
 Driver Built-in constant current DC700mA 36V
 Operating Temperature -25°C~+50°

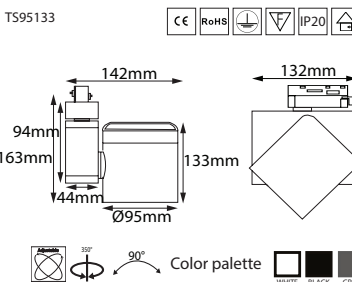

TS95133 Track Spotlight

Input Voltage 220-240VAC Multivoltage / 50-60Hz
 Light Power 32W
 Luminous flux ~2900lm
 Light Source CREE COB
 CCT 2700K, 3000K, 4000K, 5000K
 CRI >80 CRI>90
 Optical components Lens and honey comb
 Beam Angle Reflector 20°, 30°, 40°
 Driver Built-in constant current DC900mA 36V
 Operating Temperature -25°C~+50°



VANZO SERIES



TS111155 Track Spotlight

Input Voltage 220-240VAC Multivoltage / 50-60Hz
 Light Power 11W
 Luminous flux ~840lm
 Light Source OSRAM SMT led
 CCT 2700K, 3000K, 4000K, 5000K
 CRI >80
 Optical components Lens and honey comb
 Beam Angle Reflector 90°
 Driver Built-in constant current DC300mA 36V
 Operating Temperature -25°c~+50°

TS111155

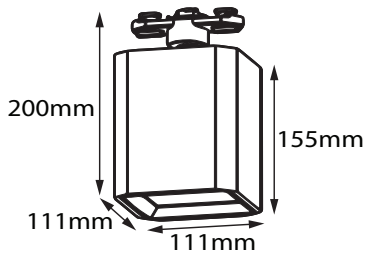

TS300110

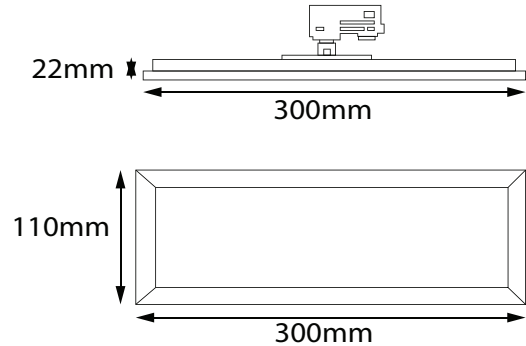

TS300110 Track Spotlight

Input Voltage 100-240VAC/ 50-60Hz
 Light Power 20W
 Luminous flux ~1500lm
 Light Source SAMSUNG
 CCT 3000K, 4000K, 5000K
 CRI >80
 Optical components LGP
 Beam Angle Reflector 90°
 Driver Built-in constant current
 Operating Temperature -25°c~+50°

FLY SERIES