

THE COLLECTION 2021

LED LINEAR TRACK



**COMMERCIAL & RESIDENTIAL
OUTDOOR LIGHTING**



ARCHITECTURAL LIGHTING

nelux hong kong international, ltd

LED LINEAR LIGHT COLLECTION

nelux architectural lighting

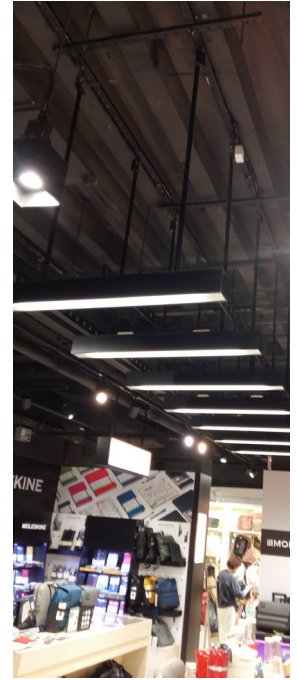

The Led Linear Track Light can be easily integrated into your projects and provide the necessary light therefore creating a pleasant atmosphere and the right illumination. Different sizes, models, and lumens available for any installation you need.

LED LINEAR LIGHT TRACK

lighting product designers and mold management



GENERAL FEATURES

Light housing made of high quality extruded aluminum Integrated with heat sink from die-casting aluminium Advanced thermal management technology to ensure consistency of LED life span, color temperature and maximize output lumens.
High transmittance PMMA diffuser creating a high visual comfort and uniform lighting distributions or black frame reflectors or black frame and lens
Light Source SMD 3030 and SMD2835 led light source ~90lm/W and also available ~120lm/W CRI>80 as standard and available CRI90
Input voltage Multivoltage and 220-240VAC 50/60Hz
Led Driver High Standards Led driver, dimmable as an option 1-10V, Dali and white Temperature control.
Mounting Options Different mounting options Track mounted, surface, recessed and suspended
Applications Institutes, Hospitals, Warehouses, Hospitality Retail, Fake ceiling, concealed spaces ,ETC

Product Image

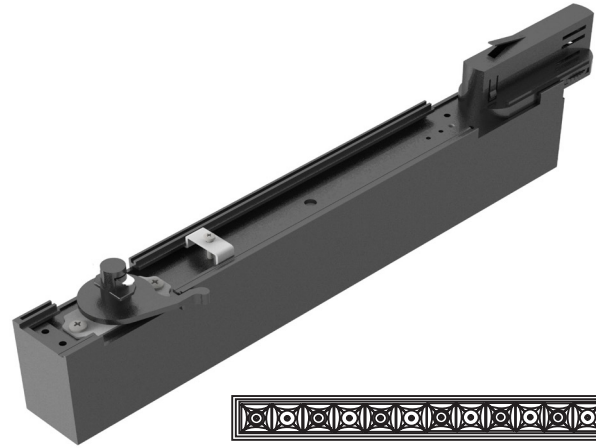

nelux CCT available correlated colour temperature

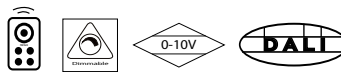

Colour Palette



LLT340L

Diffuser lens

Light Source SMD3030 Philips or Samsung
 Power 15W
 Beam Angle 10°, 24°, 38°
 CCT 2700K 1200lm, 3000K 1300lm, 4000K 1400lm
 Size Length 328mm, Width 37mm, Height 72mm

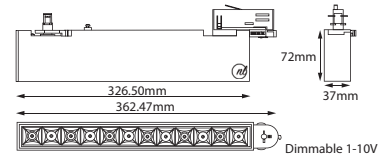
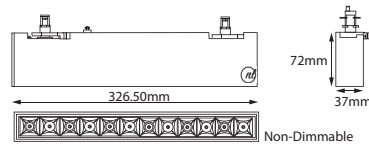

LLT645L

Diffuser lens

Light Source SMD3030 Philips or Samsung
 Power 30W
 Beam Angle 10°, 24°, 38°
 CCT 2700K 2300lm, 3000K 2400lm, 4000K 2450lm
 Size Length 646mm, Width 37mm, Height 72mm

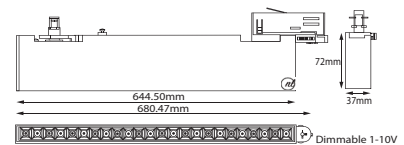
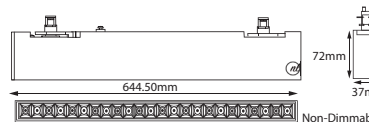

LLT965L

Diffuser lens

Light Source SMD3030 Philips or Samsung
 Power 40W
 Beam Angle 10°, 24°, 38°
 CCT 2700K 3100lm, 3150K 2400lm, 4000K 3200lm
 Size Length 962.5mm, Width 37mm, Height 72mm

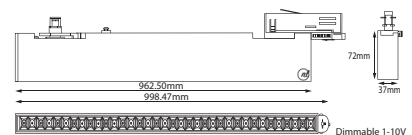
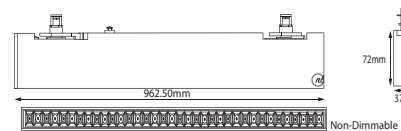

Mounting Options

Mountable on DIN 35 rail / Montaje en carril-riel

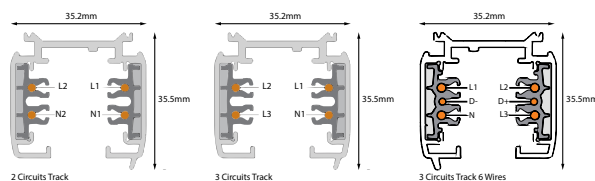

LED LINEAR LIGHT TRACK

lighting product designers and mold management



GENERAL FEATURES

Light housing made of high quality extruded aluminum Integrated with heat sink from die-casting aluminium Advanced thermal management technology to ensure consistency of LED life span, color temperature and maximize output lumens.
High transmittance PMMA diffuser creating a high visual comfort and uniform lighting distributions or black frame reflectors
Light Source SMD 3030 and SMD2835 led light source ~90lm/W and also available ~120lm/W CRI>80 as standard and available CRI90
Input voltage Multivoltage and 220-240VAC 50/60Hz
Led Driver High Standards Led driver, dimmable as an option 1-10V, Dali and white Temperature control.
Mounting Options Different mounting options Track mounted, surface, recessed and suspended
Applications Institutes, Hospitals, Warehouses, Hospitality Retail, Fake ceiling, concealed spaces ,ETC

Product Image

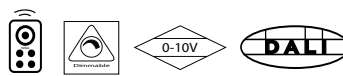
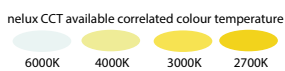
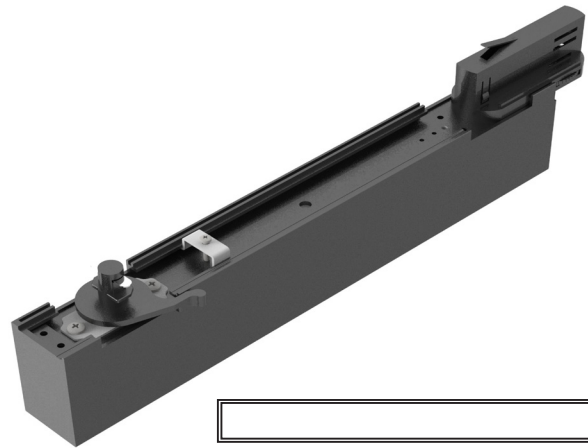

Colour Palette



LLT275PC

Diffuser PC
 Light Source SMD2835 Philips or Samsung
 Power 15W
 Beam Angle 90°
 CCT 2700K 1100lm, 3000K 1150lm, 4000K 1200lm
 Size Length 275mm, Width 37mm, Height 72mm

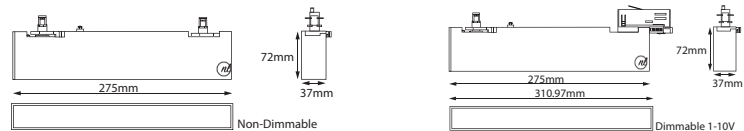

LLT540PC

Diffuser PC
 Light Source SMD2835 Philips or Samsung
 Power 30W
 Beam Angle 90°
 CCT 2700K 2200lm, 3000K 2250lm, 4000K 2300lm
 Size Length 540mm, Width 37mm, Height 72mm

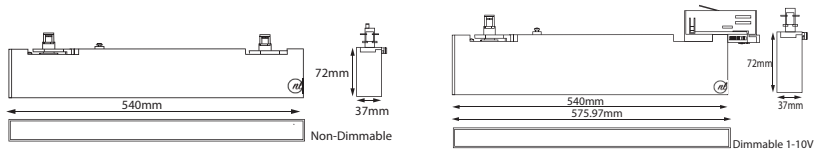

LLT1070PC

Diffuser PC
 Light Source SMD2835 Philips or Samsung
 Power 40W
 Beam Angle 90°
 CCT 2700K 3050lm, 3150K 3100lm, 4000K 3150lm
 Size Length 1070mm, Width 37mm, Height 72mm

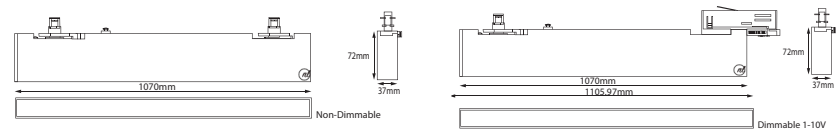

Mounting Options

Mountable on DIN 35 rail / Montaje en carril-riel

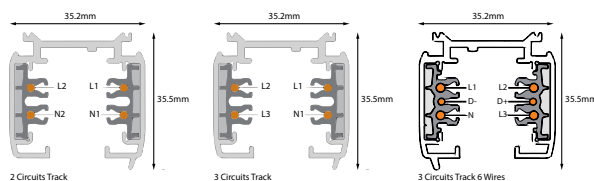

LED LINEAR LIGHT TRACK





GENERAL FEATURES

Light housing made of high quality extruded aluminum Integrated with heat sink from die-casting aluminium Advanced thermal management technology to ensure consistency of LED life span, color temperature and maximize output lumens.
High transmittance PMMA diffuser creating a high visual comfort and uniform lighting distributions or black frame reflectors or black frame and lens
Light Source SMD 3030 and SMD2835 led light source ~90lm/W and also available ~120lm/W CRI>80 as standard and available CRI90
Input voltage Multivoltage and 220-240VAC 50/60Hz
Led Driver High Standards Led driver, dimmable as an option 1-10V, Dali and white Temperature control.
Mounting Options Different mounting options Track mounted, surface, recessed and suspended
Applications Institutes, Hospitals, Warehouses, Hospitality Retail, Fake ceiling, concealed spaces ,ETC

Product Image

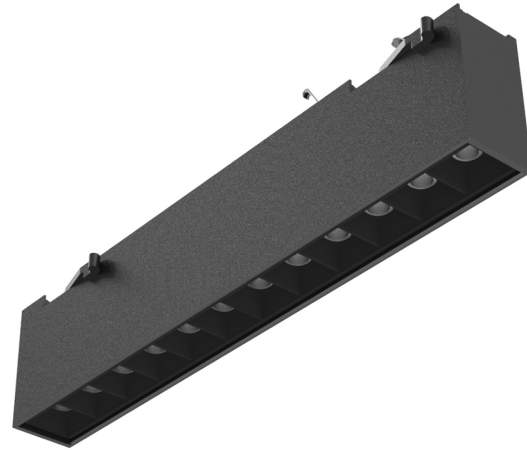

nelux CCT available correlated colour temperature



Colour Palette

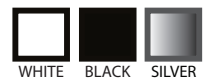

LLT340SF_L

Diffuser Black frame and lens

Light Source SMD2835 Philips or Samsung
 Power 15W
 Beam Angle 10°, 24°, 38°
 CCT 2700K 1200lm, 3000K 1300lm, 4000K 1400lm
 Size Length 328mm, Width 37mm, Height 72mm

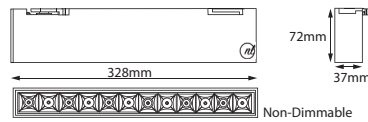

LLT646SF_L

Diffuser Black frame and lens

Light Source SMD2835 Philips or Samsung
 Power 30W
 Beam Angle 10°, 24°, 38°
 CCT 2700K 2300lm, 3000K 2400lm, 4000K 2450lm
 Size Length 646mm, Width 37mm, Height 72mm



LLT965SF_L

Diffuser Black frame and lens

Light Source SMD2835 Philips or Samsung
 Power 40W
 Beam Angle 10°, 24°, 38°
 CCT 2700K 3100lm, 3150K 3150lm, 4000K 3200lm
 Size Length 964mm, Width 37mm, Height 72mm

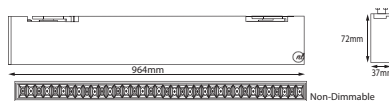

Mounting Options

Surface Mounted / Montaje en Superficie



GENERAL FEATURES

Light housing made of high quality extruded aluminum Integrated with heat sink from die-casting aluminium Advanced thermal management technology to ensure consistency of LED life span, color temperature and maximize output lumens.

High transmittance PMMA diffuser creating a high visual comfort and uniform lighting distributions or black frame reflectors

Light Source SMD 3030 and SMD2835 led light source ~90lm/W and also available ~120lm/W CRI>80 as standard and available CRI90

Input voltage Multivoltage and 220-240VAC 50/60Hz

Led Driver High Standards Led driver, dimmable as an option 1-10V, Dali and white Temperature control.

Mounting Options Different mounting options Track mounted, surface, recessed and suspended

Applications Institutes, Hospitals, Warehouses, Hospitality Retail, Fake ceiling, concealed spaces ,ETC

Product Image

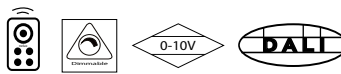
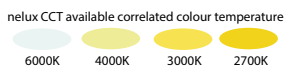
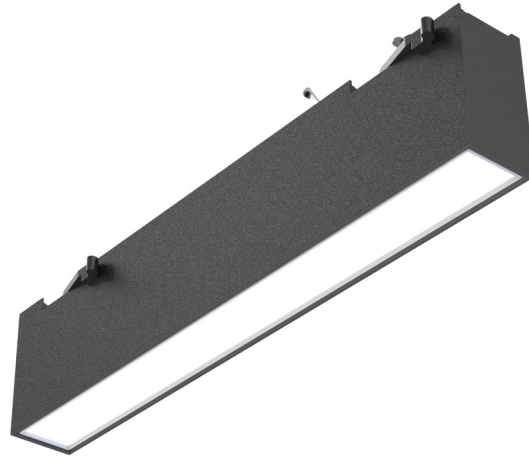

Colour Palette



LLT340SF_PC

Diffuser PC

Light Source SMD2835 Philips or Samsung

Power 15W

Beam Angle 90°

CCT 2700K 1200lm, 3000K 1300lm, 4000K 1400lm

Size Length 328mm, Width 37mm, Height 72mm

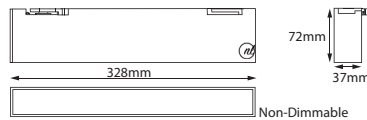

LLT646SF_PC

Diffuser PC

Light Source SMD2835 Philips or Samsung

Power 30W

Beam Angle 90°

CCT 2700K 2300lm, 3000K 2400lm, 4000K 2450lm

Size Length 646mm, Width 37mm, Height 72mm

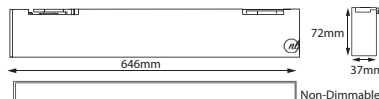

LLT965SF_PC

Diffuser PC

Light Source SMD2835 Philips or Samsung

Power 40W

Beam Angle 90°

CCT 2700K 3100lm, 3150K 3150lm, 4000K 3200lm

Size Length 964mm, Width 37mm, Height 72mm

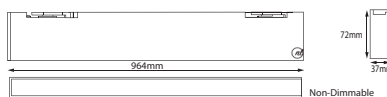

Mounting Options

Surface Mounted / Montaje en Superficie

GENERAL FEATURES

Light housing made of high quality extruded aluminum Integrated with heat sink from die-casting aluminium Advanced thermal management technology to ensure consistency of LED life span, color temperature and maximize output lumens.
High transmittance PMMA diffuser creating a high visual comfort and uniform lighting distributions or black frame reflectors or black frame and lens
Light Source SMD 3030 and SMD2835 led light source ~90lm/W and also available ~120lm/W CRI>80 as standard and available CRI90
Input voltage Multivoltage and 220-240VAC 50/60Hz
Led Driver High Standards Led driver, dimmable as an option 1-10V, Dali and white Temperature control.
Mounting Options Different mounting options Track mounted, surface, recessed and suspended
Applications Institutes, Hospitals, Warehouses, Hospitality Retail, Fake ceiling, concealed spaces ,ETC

Product Image

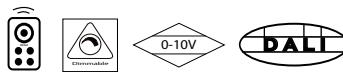
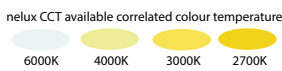
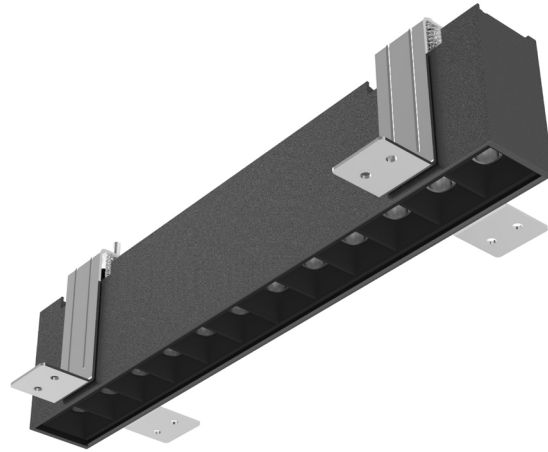

Colour Palette

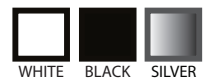

LLT340RC_L

Diffuser Black frame and lens
 Light Source SMD2835 Philips or Samsung
 Power 15W
 Beam Angle 10°, 24°, 38°
 CCT 2700K 1200lm, 3000K 1300lm, 4000K 1400lm
 Size Length 328mm, Width 37mm, Height 72mm

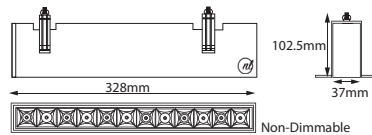

LLT646RC_L

Diffuser Black frame and lens
 Light Source SMD2835 Philips or Samsung
 Power 30W
 Beam Angle 10°, 24°, 38°
 CCT 2700K 2300lm, 3000K 2400lm, 4000K 2450lm
 Size Length 646mm, Width 37mm, Height 72mm

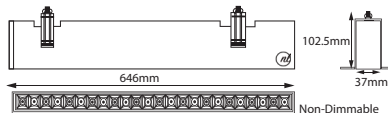

LLT965RC_L

Diffuser Black frame and lens
 Light Source SMD2835 Philips or Samsung
 Power 40W
 Beam Angle 10°, 24°, 38°
 CCT 2700K 3100lm, 3150K 3150lm, 4000K 3200lm
 Size Length 964mm, Width 37mm, Height 72mm

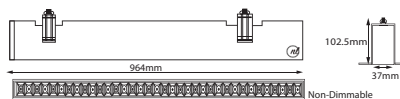

Mounting Options

Recessed Mounted / Montaje empotrado en techo



GENERAL FEATURES

Light housing made of high quality extruded aluminum Integrated with heat sink from die-casting aluminium Advanced thermal management technology to ensure consistency of LED life span, color temperature and maximize output lumens.
High transmittance PMMA diffuser creating a high visual comfort and uniform lighting distributions or black frame reflectors
Light Source SMD 3030 and SMD2835 led light source ~90lm/W and also available ~120lm/W CRI>80 as standard and available CRI90
Input voltage Multivoltage and 220-240VAC 50/60Hz
Led Driver High Standards Led driver, dimmable as an option 1-10V, Dali and white Temperature control.
Mounting Options Different mounting options Track mounted, surface, recessed and suspended
Applications Institutes, Hospitals, Warehouses, Hospitality Retail, Fake ceiling, concealed spaces ,ETC

Product Image

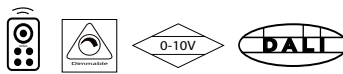
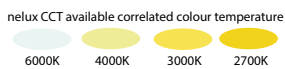
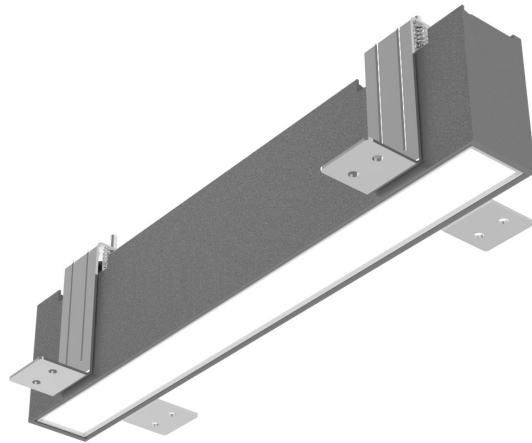

Colour Palette



LLT340RC_PC

Diffuser PC

Light Source SMD2835 Philips or Samsung
 Power 15W
 Beam Angle 90°
 CCT 2700K 1100lm, 3000K 1150lm, 4000K 1200lm
 Size Length 328mm, Width 37mm, Height 72mm

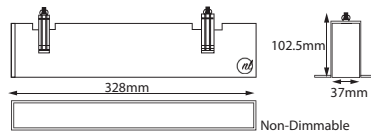

LLT646RC_PC

Diffuser PC

Light Source SMD2835 Philips or Samsung
 Power 30W
 Beam Angle 90°
 CCT 2700K 2200lm, 3000K 2250lm, 4000K 2300lm
 Size Length 646mm, Width 37mm, Height 72mm

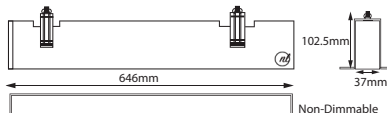

LLT965RC_PC

Diffuser PC

Light Source SMD2835 Philips or Samsung
 Power 40W
 Beam Angle 90°
 CCT 2700K 3050lm, 3000K 3100lm, 4000K 3150lm
 Size Length 964mm, Width 37mm, Height 72mm

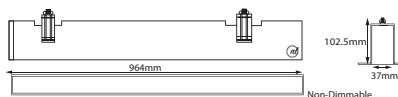

Mounting Options

Recessed Mounted / Montaje empotrado en techo



GENERAL FEATURES

Light housing made of high quality extruded aluminum Integrated with heat sink from die-casting aluminium Advanced thermal management technology to ensure consistency of LED life span, color temperature and maximize output lumens.

High transmittance PMMA diffuser creating a high visual comfort and uniform lighting distributions or black frame reflectors or black frame and lens

Light Source SMD 3030 and SMD2835 led light source ~90lm/W and also available ~120lm/W CRI>80 as standard and available CRI90

Input voltage Multivoltage and 220-240VAC 50/60Hz

Led Driver High Standards Led driver, dimmable as an option 1-10V, Dali and white Temperature control.

Mounting Options Different mounting options Track mounted, surface, recessed and suspended

Applications Institutes, Hospitals, Warehouses, Hospitality Retail, Fake ceiling, concealed spaces ,ETC

Product Image

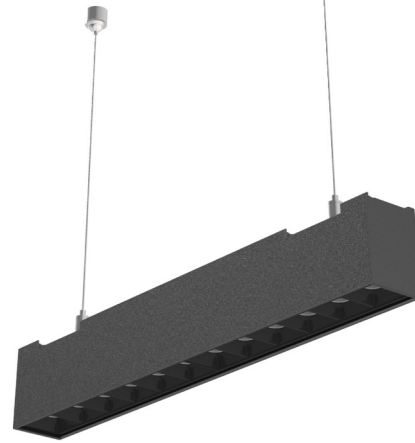

nelux CCT available correlated colour temperature

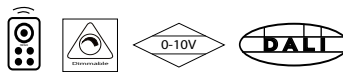

Colour Palette



LLT340PD_L

Diffuser Black Frame and Lens

Light Source SMD2835 Lumileds, Samsung

Power 15W

Beam Angle 10°, 24°, 38°

CCT 2700K-1200lm, 3000K-1300lm, 4000K-1400lm

Size L328*W37*H73mm

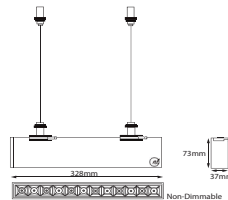

LLT645PD_L

Diffuser Black Frame and Lens

Light Source SMD2835 Lumileds, Samsung

Power 30W

Beam Angle 10°, 24°, 38°

CCT 2700K-2300lm, 3000K-2400lm, 4000K-2450lm

Size L646*W37*H73mm

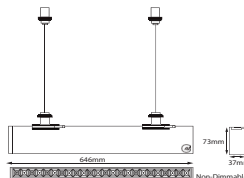

LLT965PD_L

Diffuser Black Frame and Lens

Light Source SMD2835 Lumileds, Samsung

Power 40W

Beam Angle 10°, 24°, 38°

CCT 2700K-3100lm, 3000K-3150lm, 4000K-3200lm

Size L964*W37*H73mm

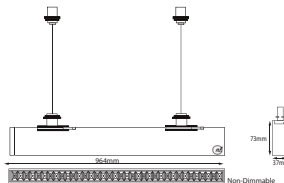

Mounting Options

Pendant mounted / Montaje suspendido



GENERAL FEATURES

Light housing made of high quality extruded aluminum Integrated with heat sink from die-casting aluminium Advanced thermal management technology to ensure consistency of LED life span, color temperature and maximize output lumens.

High transmittance PMMA diffuser creating a high visual comfort and uniform lighting distributions or black frame reflectors

Light Source SMD 3030 and SMD2835 led light source ~90lm/W and also available ~120lm/W CRI>80 as standard and available CRI90

Input voltage Multivoltage and 220-240VAC 50/60Hz

Led Driver High Standards Led driver, dimmable as an option 1-10V, Dali and white Temperature control.

Mounting Options Different mounting options Track mounted, surface, recessed and suspended

Applications Institutes, Hospitals, Warehouses, Hospitality Retail, Fake ceiling, concealed spaces ,ETC

Product Image

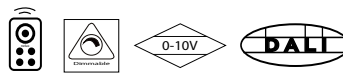
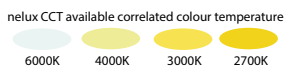
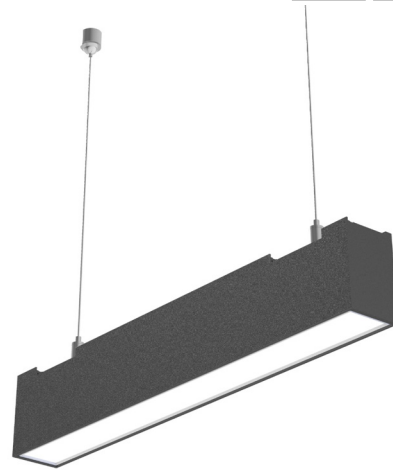

Colour Palette



LLT340PD_PC

Diffuser PC

Light Source SMD2835 Philips or Samsung

Power 15W

Beam Angle 90°

CCT 2700K 1100lm, 3000K 1150lm, 4000K 1200lm

Size Length 328mm, Width 37mm, Height 73mm

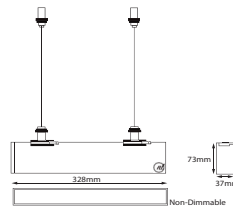

LLT645PD_PC

Diffuser PC

Light Source SMD2835 Philips or Samsung

Power 30W

Beam Angle 90°

CCT 2700K 2200lm, 3000K 2250lm, 4000K 2300lm

Size Length 646mm, Width 37mm, Height 73mm

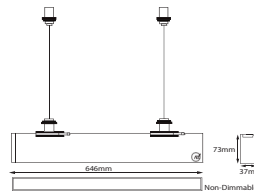

LLT965PD_PC

Diffuser PC

Light Source SMD2835 Philips or Samsung

Power 40W

Beam Angle 90°

CCT 2700K 3050lm, 3150K 3100lm, 4000K 3150lm

Size Length 964mm, Width 37mm, Height 73mm

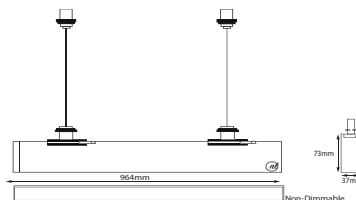

Mounting Options

Pendant mounted / Montaje suspendido