

THE NEW COLLECTION

Led linear light collection

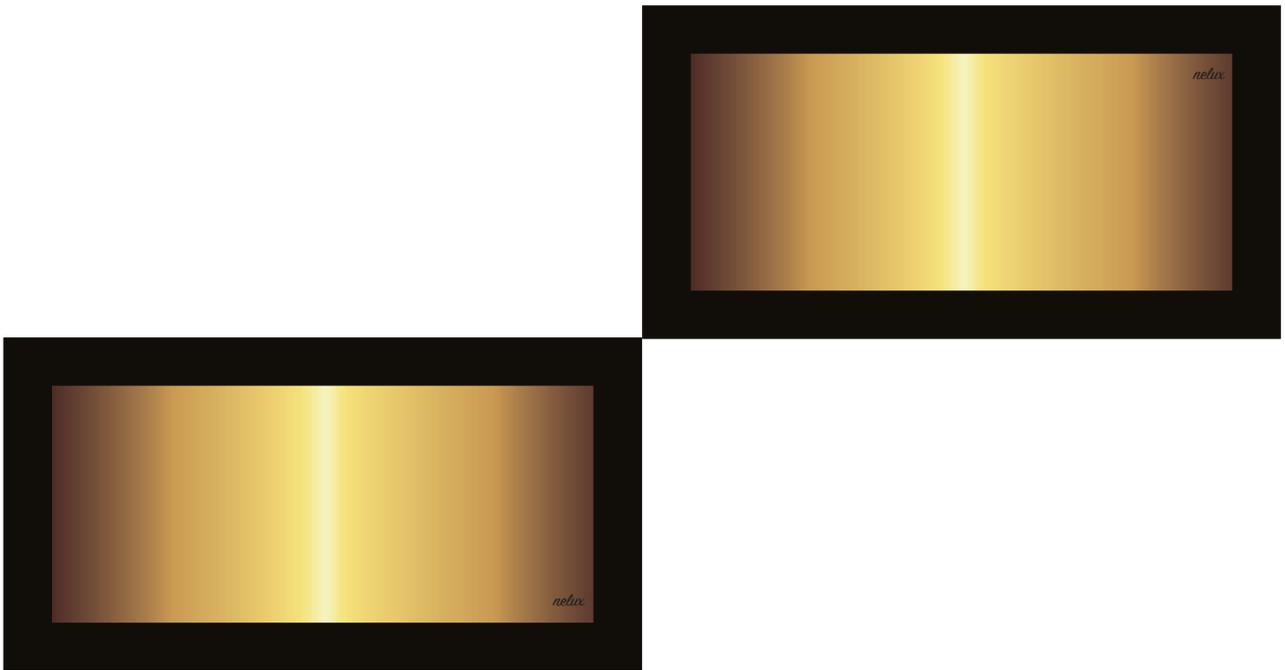

ARCHITECTURAL LIGHTING

nelux hong kong international, ltd
2020-2021

hotel
shops
home
office
cafe....



nelux (HK) international, ltd

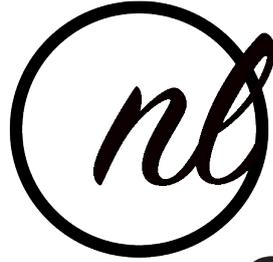

PROFILE

Nelux Hong Kong International, Ltd located in Tuen Mun Industrial area in Hong Kong, with a convenient location in Asia to export all over the world.

Since founded in 2010, we have been focusing on designing, and producing architectural lighting products. We work with first-class led technology and craft, working with the best equipment in the market providing high quality products and good service to our customers.

QUALITY

Nelux is committed to the developing, production and distribution of led lighting products with the best quality in accessories, assembling and finishing products. At present to determine the quality of our products we have mastered the leading core technology, which makes our products reach the international advance levels. Main and basic parameters in our led lights: Chips, Optical, Reflectors, and Thermal Management.

Chips, using the top brands in the market we can achieve the best quality of our products. Optical, the suitable reflectors or lens is a fundamental part of our products, making the illuminated objects get their right texture and value.

Reflectors, nelux install the precision reflectors for each model, to make beam angle accurate, and getting a uniformity in lighting distribution. Working with spot, medium and flood beam angle with a wide range of degrees according to customer needs.

Thermal Management, not only the life of the light source is decided but its own quality, but also affects the lighting fixture quality. The life of LED is related to Nelux Hong Kong International, Ltd located in Tuen Mun Industrial area in Hong Kong, with a convenient location in Asia to export all over the world.

ABOUT US



The Nelux Hong Kong International, Ltd is a design, research, development, distribution, production, sales and service company in one of the integrated Smart Home and LED lighting enterprises.

Nelux architectural lighting, since the establishment of the company, maintains a high-speed growth, and gradually becomes the leading enterprise in the LED lighting industry. In Hong Kong, Nelux architectural lighting has two bases our head office in Wanchai and our assembling workhouse in Tuen Mun.

In the worldwide, 95% of our products to the export, sold to over 15 countries around world. We also sets up a wide range of agents, marketing, after-sales networks across the world. Such as Europe, South America, The Middle East, and Hong Kong.

Through the years cautious and conscientious work, our linear products and lighting project has built a great reputation in the customer's local markets.

The different LED series we introduce in this catalog is not only the realization of the traditional energy-saving lighting, but also it embodies the concept of innovation, unique design style and customer exclusive customization. Once introduced, it has been unanimously praised and trusted by the users at home and abroad.

Rely on many years of unremitting efforts, continuous development, based on advanced management mechanism, strong R & D strength, complete marketing network and sound service system. Our products and One-stop overall lighting customized solutions (scheme design + customization products +

intelligent control system + installation service) are the first choice of many illuminating Engineering contractors and lighting interior design companies.

Our products are widely used in high-grade hotels, high-end commercial real estate, office, industrial and numerous of civilian areas. fully meet the market demand of high-end lighting. Finally in September 2018, our company show up in the lead trend of the industry development and launch new products you can see in this new catalog. This series highlights the simplicity, fashion, beautiful design style, elaborates the perfect combination of light and beauty once again.

All the time always stuck to business philosophy of "Adherence to Commitment, Prompt and High efficient, Harmony and Mutual win". The company's brand concept of "Creating value for you" also has been deeply rooted in our client's mind.

We always adhere to the values of focusing on customer's demands, sincerity-oriented, and trust-based. Humanistic management is our mile stone of enterprise development.

We are focus on every product, every lighting project, and strive to provide competitive products, services and high effective one-stop-shop solutions for the enterprise customers and consumers.

Thank you for your continued support! Welcome to contact us!

Nelux Hong Kong International, Ltd



ARCHITECTURAL LIGHTING

LED LINEAR LIGHT COLLECTION	
LED LINEAR LIGHT PROFILES	PAGES.....6-38
LED LINEAR LIGHT TRACKS	PAGES.....39-47
LED TRACK SPOT LIGHT	PAGES.....48-58
MINI SPOTLIGHT	PAGES.....59-62
MINI COMBI AND COMBI	PAGES.....63-67
DECORATIVE LAMPS	PAGES.....68-74
CEILING SURFACE	PAGES.....75-83
BED LIGHT	PAGES.....84-89
SHOWCASE ILLUMINATION	PAGES.....90-94
CEILING RECESSED	PAGES.....95-98
DOWNLIGHT	PAGES.....99-104
SPOT LIGHT	PAGES.....105-113
WALL WASJER DOWNLIGHT	PAGES.....114-116
INLINE	PAGES.....117-121
IP54 AND IP65 DOWNLIGHT	PAGES.....122-126
GRILLE LIGHT / CARDAN	PAGES.....127-131

COMMERCIAL AND RESIDENTIAL OUTDOOR LIGHTING

INGROUND	PAGES.....132-141
WALL RECESSED	PAGES.....142-147
LED PROJECTOR	PAGES.....148-154
SPIKE SPOTLIGHT	PAGES.....155-165



Led Linear Light Collection

These versatile Led Linear Light Profiles and Led Linear Tracks works any project you desire give a high end status/ Tanto los perfiles lineales como el lineal para carril son muy versatiles para proyectos donde prime la calidad.

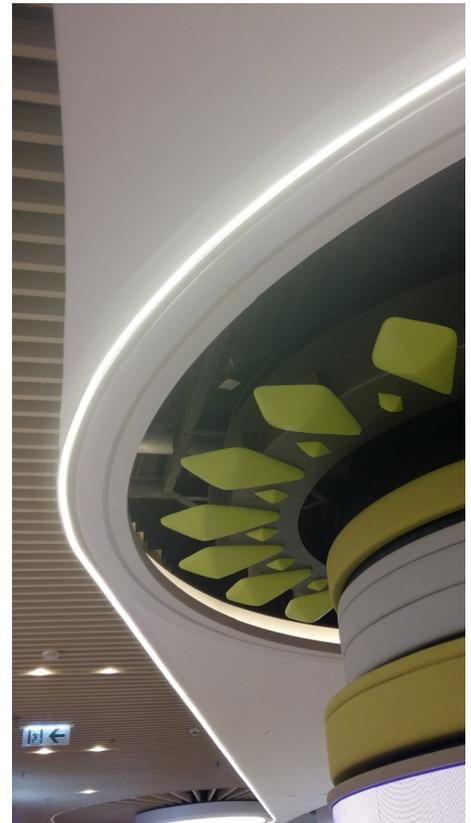

Customising, any profile needed we can customize as your wish. / Indiquenos las necesidades de su proyecto y le fabricamos el perfil segun sus necesidades



Wide Range of Applications/Multiples aplicaciones

These versatile profiles works well for a wide range of applications, shops, Hotels, Restaurants, Home,Offices.../ Nuestros perfiles disponen de una amplia gama de aplicaciones en Tiendas, Hogar, Restaurantes, Hoteles, Oficinas

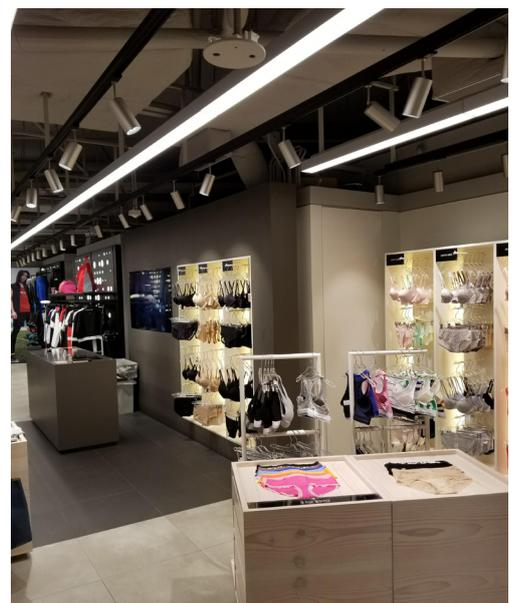

LED LINEAR LIGHT PROFILES

lighting product designers and mold management





Optional

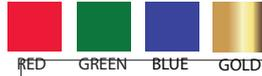

nelux CCT available correlated colour temperature

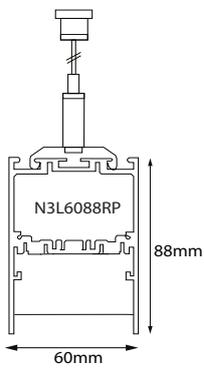
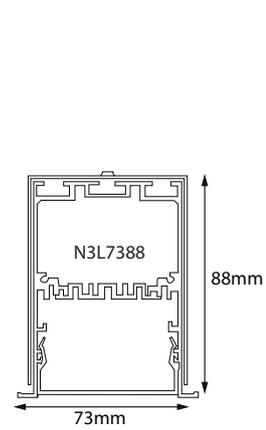
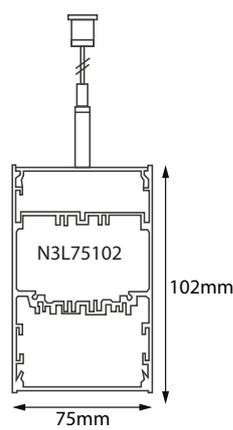
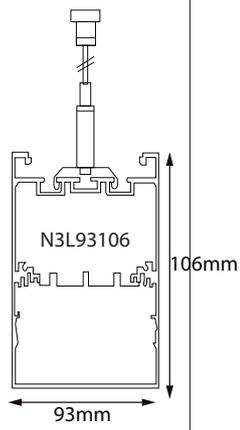
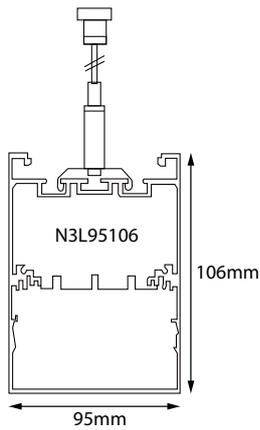
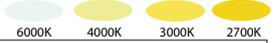

Diffuser Recessed

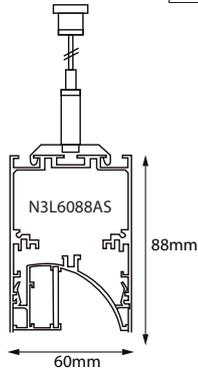

Asymmetric Diffuser

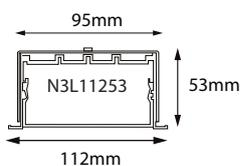
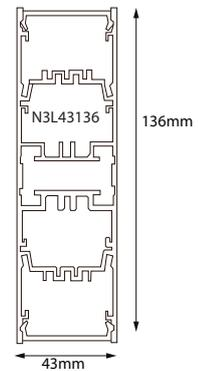
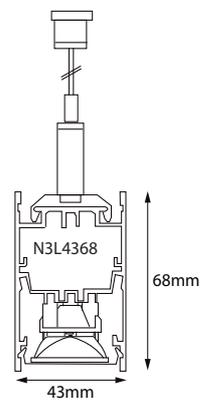
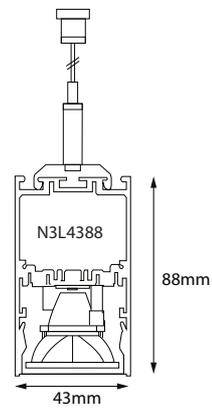
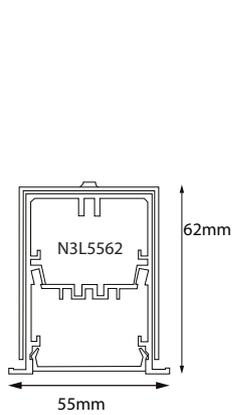
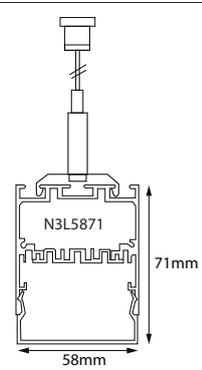
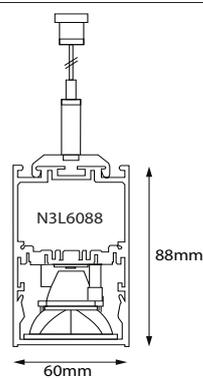

LED LINEAR LIGHT PROFILES

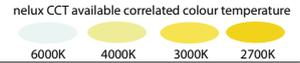

GENERAL FEATURES

Light housing made of high quality extruded aluminum Integrated with rotatable connectors at both ends makes it adjustable and uniform light output

High transmittance PMMA diffuser creating a high visual comfort and uniform lighting distributions

Light Source SMD led light source ~90lm/W and also available ~120lm/W CRI>80 as standard and available CRI90

Input voltage Multivoltage and 220-240VAC

Led Driver High Standards Led driver, dimmable as an option 1-10V, Dali and white Temperature control.

Intelligent control options, microwave sensor, daylight, wifi, bluetooth.

Mounting Options Different mounting options wall mounted, surface, recessed, suspended

No need to connect the wire, maximum 50pcs allowed to be connected for one single circuit.

Advanced thermal management technology to ensure consistency of LED life span, color temperature and maximize output lumens

Applications Institutes, Hospitals, Warehouses, Hospitality Retail, Fake ceiling, concealed spaces ,ETC

MAIN PRODUCT FEATURES

MODEL	Unit reflectors	Power	Lumens	Size
4368CM	PMMA	15W	1200lm	595*43*68mm
	PMMA	20W	1700lm	890*43*68mm
	PMMA	30W	2500lm	1180*43*68mm
	PMMA	36W	3000lm	1470*43*68mm
	PMMA	45W	3800lm	1760*43*68mm
	PMMA	50W	4200lm	2050*43*68mm
	PMMA	60W	5100lm	2340*43*68mm

Connectors
L 8W L 8W L 8W T 12W X 15W

Frame and accessories

continuous connector suspension wire installation buckle

Mounting Options

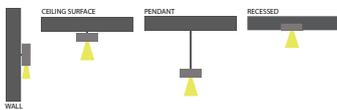

Colour Palette



Optional



Product Image



Dimensions

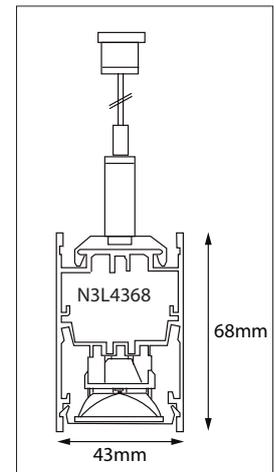

Standard Single Fittings/ Configuraciones basicas

Seamless continuous lighting system without dark spots
 Customized lighting system with our latest addition of system connection module
 Various mounting options available-Ceiling Surface/Wall mounted/suspended/recessed

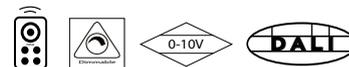

nelux CCT available correlated colour temperature



GENERAL FEATURES

Light housing made of high quality extruded aluminum Integrated with rotatable connectors at both ends makes it adjustable and uniform light output

High transmittance PMMA diffuser creating a high visual comfort and uniform lighting distributions

Light Source SMD led light source ~90lm/W and also available ~120lm/W CRI>80 as standard and available CRI90

Input voltage Multivoltage and 220-240VAC

Led Driver High Standards Led driver, dimmable as an option 1-10V, Dali and white Temperature control.

Intelligent control options , microwave sensor, daylight, wifi, bluetooth.

Mounting Options Different mounting options wall mounted, surface, recessed, suspended

No need to connect the wire, maximum 50pcs allowed to be connected for one single circuit.

Advanced thermal management technology to ensure consistency of LED life span,

color temperature and maximize output lumens

Applications Institutes, Hospitals, Warehouses, Hospitality Retail, Fake ceiling, concealed spaces ,ETC

MAIN PRODUCT FEATURES

MODEL	Unit reflectors	Power	Lumens	Size
436855P	2*5W+20W	30W	2050lm	1180*43*68mm

Pendant and Union Accessories

continuous connector

suspension wire

installation buckle

Mounting Options

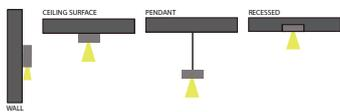

Colour Palette



Optional



Product Image

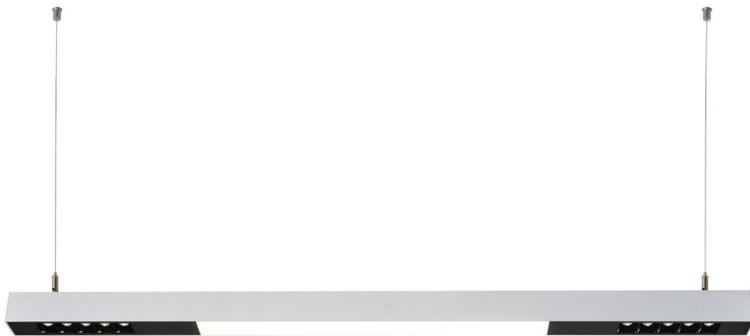

Dimensions

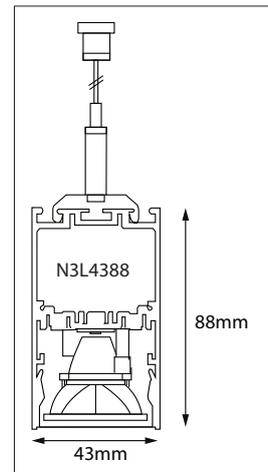

Standard Single Fittings/ Configuraciones basicas

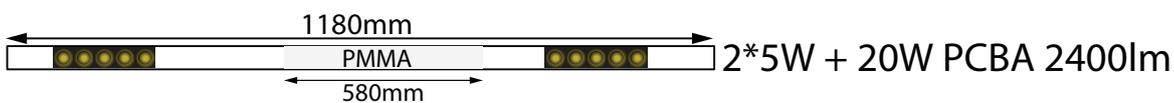
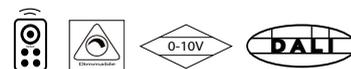

LED LINEAR LIGHT PROFILES



nelux CCT available correlated colour temperature
 6000K 4000K 3000K 2700K

GENERAL FEATURES

Light housing made of high quality extruded aluminum Integrated with rotatable connectors at both ends makes it adjustable and uniform light output
High transmittance PMMA diffuser creating a high visual comfort and uniform lighting distributions
Light Source SMD led light source ~90lm/W and also available ~120lm/W CRI>80 as standard and available CRI90
Input voltage Multivoltage and 220-240VAC
Led Driver High Standards Led driver, dimmable as an option 1-10V, Dali and white Temperature control.
Intelligent control options , microwave sensor, daylight, wifi, bluetooth.
Mounting Options Different mounting options wall mounted, surface, recessed, suspended
 No need to connect the wire, maximum 50pcs allowed to be connected for one single circuit.
 Advanced thermal management technology to ensure consistency of LED life span, color temperature and maximize output lumens
Applications Institutes, Hospitals, Warehouses, Hospitality Retail, Fake ceiling, concealed spaces ,ETC

MAIN PRODUCT FEATURES

MODEL	Unit reflectors	Power	Lumens	Size
4368S1	2*10W	20W	1900lm	890*43*68mm
	3*10W	30W	2850lm	1000*43*68mm
	3*10W	30W	2850lm	1180*43*68mm
	4*10W	40W	3700lm	1000*43*68mm
	5*10W	50W	4500lm	1150*43*68mm
	5*10W	50W	4500lm	1500*43*68mm
	6*10W	60W	5400lm	2000*43*68mm

Pendant and Union Accessories



continuous connector



suspension wire



installation buckle

Mounting Options

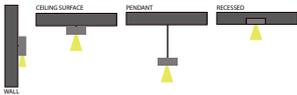

Colour Palette



Optional

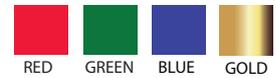

Product Image



Dimensions

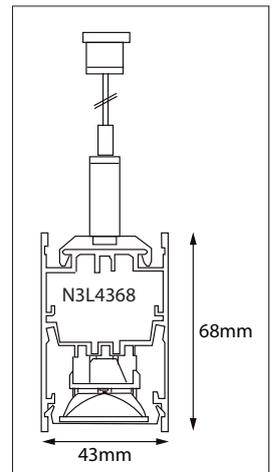

Standard Single Fittings/ Configuraciones basicas

- 888mm 2*10W 20W 1800lm
- 1000mm 3*10W 30W 2700lm
- 1000mm 4*10W 40W 3600lm
- 1150mm 5*10W 50W 4500lm
- 1180mm 3*10W 30W 2700lm
- 1500mm 9*10W 90W 8100lm
- 1800mm 4*10W 40W 3600lm
- 2000mm 5*10W 50W 4500lm
- 2100mm 12*10W 120W 10800lm
- 2340mm 6*10W 60W 5400lm

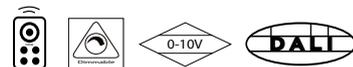

nelux CCT available correlated colour temperature



GENERAL FEATURES

Light housing made of high quality extruded aluminum Integrated with rotatable connectors at both ends makes it adjustable and uniform light output

High transmittance PMMA diffuser creating a high visual comfort and uniform lighting distributions

Light Source SMD led light source ~90lm/W and also available ~120lm/W CRI>80 as standard and available CRI90

Input voltage Multivoltage and 220-240VAC

Led Driver High Standards Led driver, dimmable as an option 1-10V, Dali and white Temperature control.

Intelligent control options , microwave sensor, daylight, wifi, bluetooth.

Mounting Options Different mounting options wall mounted, surface, recessed, suspended

No need to connect the wire, maximum 50pcs allowed to be connected for one single circuit.

Advanced thermal management technology to ensure consistency of LED life span,

color temperature and maximize output lumens

Applications Institutes, Hospitals, Warehouses, Hospitality Retail, Fake ceiling, concealed spaces .,ETC

MAIN PRODUCT FEATURES

MODEL	Unit reflectors	Power	Lumens	Size
4368S1	10*2	20W	1900lm	600*43*68mm
	20*1.5	30W	2850lm	1000*43*68mm
	20*1.5	30W	2850lm	1180*43*68mm
	20*2	40W	3700lm	1180*43*68mm
	40*1.5	60W	5700lm	2000*43*68mm
	40*2	80W	7400lm	2000*43*68mm
	40*1.5	60W	5700lm	2350*43*68mm
	40*2	80W	7400lm	2350*43*68mm

Pendant and Union Accessories

continuous connector

suspension wire

installation buckle

Mounting Options

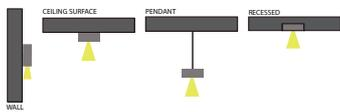

Colour Palette



Optional

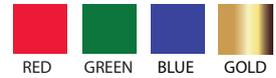

Product Image



Dimensions

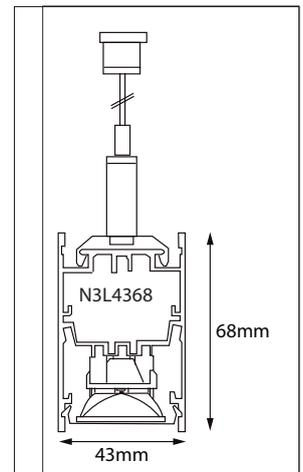

Standard Single Fittings/ Configuraciones basicas

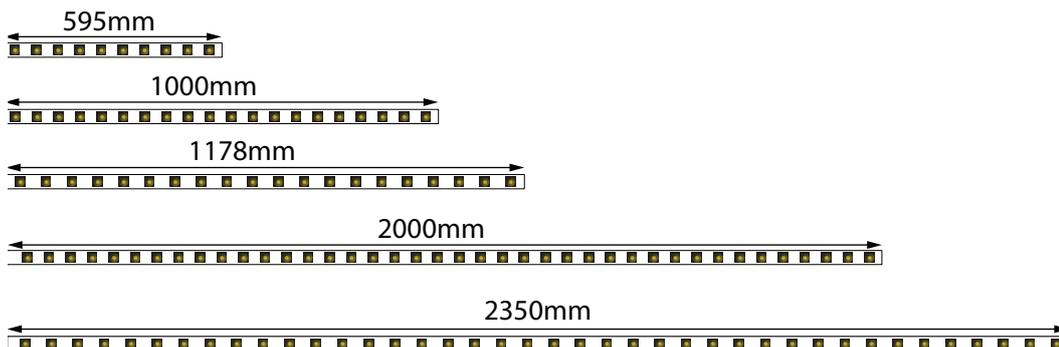
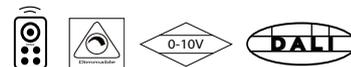

LED LINEAR LIGHT PROFILES



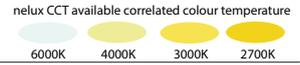

GENERAL FEATURES

Light housing made of high quality extruded aluminum Integrated with rotatable connectors at both ends makes it adjustable and uniform light output

High transmittance PMMA diffuser creating a high visual comfort and uniform lighting distributions

Light Source SMD led light source ~90lm/W and also available ~120lm/W CRI>80 as standard and available CRI90

Input voltage Multivoltage and 220-240VAC

Led Driver High Standards Led driver, dimmable as an option 1-10V, Dali and white Temperature control.

Intelligent control options , microwave sensor, daylight, wifi, bluetooth.

Mounting Options Different mounting options wall mounted, surface, recessed, suspended

No need to connect the wire, maximum 50pcs allowed to be connected for one single circuit.

Advanced thermal management technology to ensure consistency of LED life span, color temperature and maximize output lumens

Applications Institutes, Hospitals, Warehouses, Hospitality Retailers, Fake ceiling, concealed spaces ,ETC

MAIN PRODUCT FEATURES

MODEL	Unit reflectors	Power	Lumens	Size
436855C	5*2	10W	920lm	150*43*68mm
	10*1.5	15W	1400lm	290*43*68mm
	15*1.5	20W	2000lm	420*43*68mm
	20*1.5	30W	2800lm	560*43*68mm
	30*1	30W	3900lm	830*43*68mm
	40*1	40W	3700lm	1100*43*68mm

Frame and accessories

continuous connector

suspension wire

installation buckle

Mounting Options

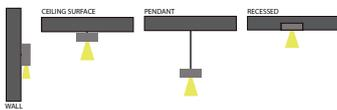

Colour Palette



Optional



Product Image



Dimensions

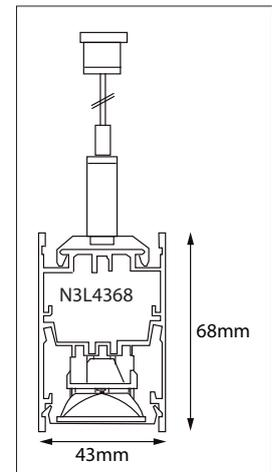

Standard Single Fittings/ Configuraciones basicas

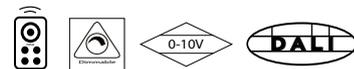

- 150mm
- 290mm
- 420mm
- 560mm
- 830mm
- 1100mm



LED LINEAR LIGHT PROFILES

nelux CCT available correlated colour temperature



GENERAL FEATURES

Light housing made of high quality extruded aluminum Integrated with rotatable connectors at both ends makes it adjustable and uniform light output

High transmittance PMMA diffuser creating a high visual comfort and uniform lighting distributions

Light Source SMD led light source ~90lm/W and also available ~120lm/W CRI>80 as standard and available CRI90

Input voltage Multivoltage and 220-240VAC

Led Driver High Standards Led driver, dimmable as an option 1-10V, Dali and white Temperature control.

Intelligent control options , microwave sensor, daylight, wifi, bluetooth.

Mounting Options Different mounting options wall mounted, surface, recessed, suspended

No need to connect the wire, maximum 50pcs allowed to be connected for one single circuit.

Advanced thermal management technology to ensure consistency of LED life span,

color temperature and maximize output lumens

Applications Institutes, Hospitals, Warehouses, Hospitality Retails, Fake ceiling, concealed spaces ,ETC

MAIN PRODUCT FEATURES

MODEL	Unit reflectors	Power	Lumens	Size
4368S1P	3*1.5W+20W	25W	2050lm	1180*43*68mm
	6*1.5W+20W	30W	2400lm	1180*43*68mm

Pendant and Union Accessories

continuous connector

suspension wire

installation buckle

Mounting Options

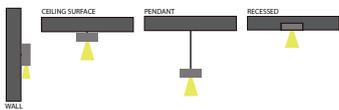

Colour Palette



Optional



Product Image



Dimensions

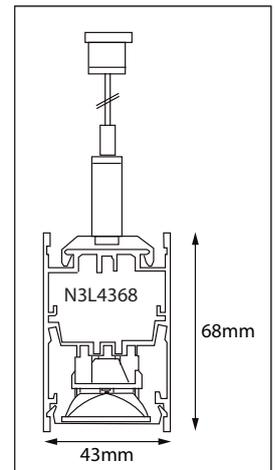

Standard Single Fittings/ Configuraciones basicas

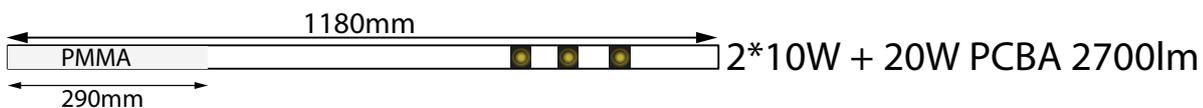
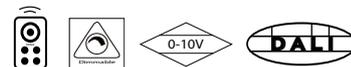

LED LINEAR LIGHT PROFILES



GENERAL FEATURES

Light housing made of high quality extruded aluminum Integrated with rotatable connectors at both ends makes it adjustable and uniform light output

High transmittance PMMA diffuser creating a high visual comfort and uniform lighting distributions

Light Source SMD led light source ~90lm/W and also available ~120lm/W CRI>80 as standard and available CRI90

Input voltage Multivoltage and 220-240VAC

Led Driver High Standards Led driver, dimmable as an option 1-10V, Dali and white Temperature control.

Intelligent control options , microwave sensor, daylight, wifi, bluetooth.

Mounting Options Different mounting options wall mounted, surface, recessed, suspended

No need to connect the wire, maximum 50pcs allowed to be connected for one single circuit.

Advanced thermal management technology to ensure consistency of LED life span,

color temperature and maximize output lumens

Applications Institutes, Hospitals, Warehouses, Hospitality Retail, Fake ceiling, concealed spaces ,ETC

MAIN PRODUCT FEATURES

nelux CCT available correlated colour temperature
 6000K 4000K 3000K 2700K

MODEL	Unit reflectors	Power	Lumens	Size
4368 2S5U	2*10W	20W	2200lm	950*43*500mm

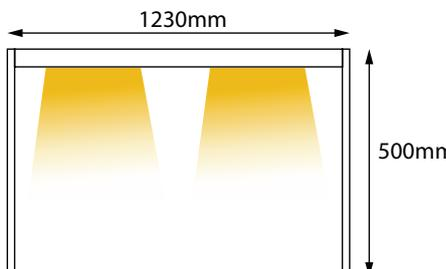

*Different possibilities available

Mounting Options

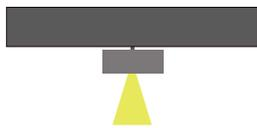

Colour Palette



Optional

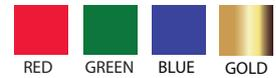

Product Image



Dimensions

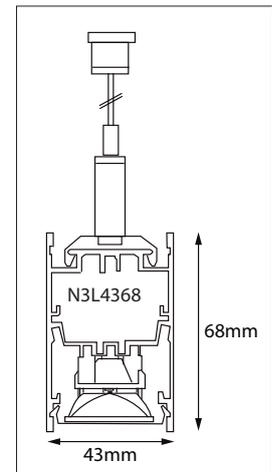

Standard Single Fittings/ Configuraciones basicas

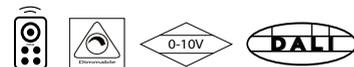

PMMA Options



10W/20W beam angle 85° SMD 2835



15W/30W beam angle 85° SMD 2835



nelux CCT available correlated colour temperature



GENERAL FEATURES

Light housing made of high quality extruded aluminum Integrated with rotatable connectors at both ends makes it adjustable and uniform light output

High transmittance PMMA diffuser creating a high visual comfort and uniform lighting distributions

Light Source SMD led light source ~90lm/W and also available ~120lm/W CRI>80 as standard and available CRI90

Input voltage Multivoltage and 220-240VAC

Led Driver High Standards Led driver, dimmable as an option 1-10V, Dali and white Temperature control.

Intelligent control options , microwave sensor, daylight, wifi, bluetooth.

Mounting Options Different mounting options wall mounted, surface, recessed, suspended

No need to connect the wire, maximum 50pcs allowed to be connected for one single circuit.

Advanced thermal management technology to ensure consistency of LED life span,

color temperature and maximize output lumens

Applications Institutes, Hospitals, Warehouses, Hospitality Retails, Fake ceiling, concealed spaces ,ETC

MAIN PRODUCT FEATURES

MODEL	Power	Lumens	Size
438855P_PJ	30W	2400lm	1180*43*88mm

Frame and accessories

- Trim 1 spot 1W~3W Light Source XPE/XBD/3035/3535
- PMMA and SMD PCB 15W/20W , 85° . Light Source SMD 2835
- Spot cob 5W~7W. Light Source Cree,Citizen

continuous connector

suspension wire

installation buckle

Mounting Options

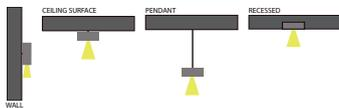

Colour Palette



Optional



Product Image

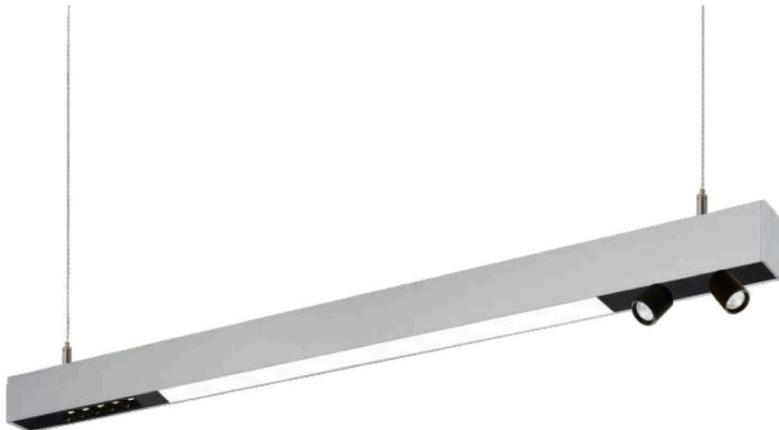

Dimensions

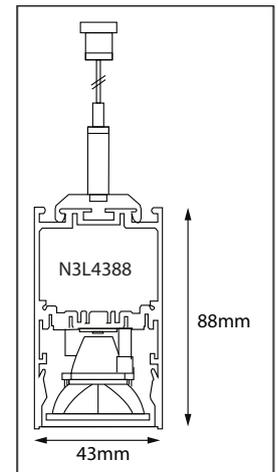

Standard Single Fittings/ Configuraciones basicas

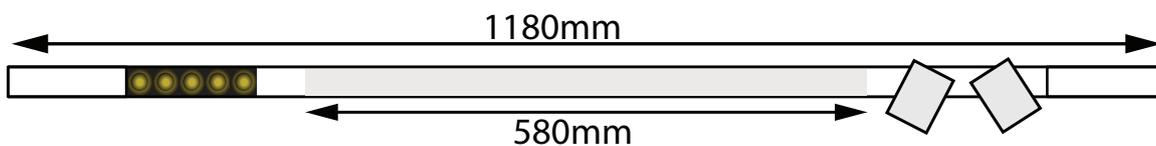
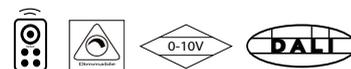

LED LINEAR LIGHT PROFILES



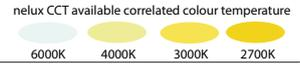

GENERAL FEATURES

Light housing made of high quality extruded aluminum Integrated with rotatable connectors at both ends makes it adjustable and uniform light output

High transmittance PMMA diffuser creating a high visual comfort and uniform lighting distributions

Light Source SMD led light source ~90lm/W and also available ~120lm/W CRI>80 as standard and available CRI90

Input voltage Multivoltage and 220-240VAC

Led Driver High Standards Led driver, dimmable as an option 1-10V, Dali and white Temperature control.

Intelligent control options , microwave sensor, daylight, wifi, bluetooth.

Mounting Options Different mounting options wall mounted, surface, recessed, suspended

No need to connect the wire, maximum 50pcs allowed to be connected for one single circuit.

Advanced thermal management technology to ensure consistency of LED life span, color temperature and maximize output lumens

Applications Institutes, Hospitals, Warehouses, Hospitality Retails, Fake ceiling, concealed spaces ,ETC

MAIN PRODUCT FEATURES

MODEL	Unit reflectors	Power	Lumens	Size
5562CMRC	PMMA	15W	1200lm	595*43*68mm
	PMMA	20W	1700lm	890*43*68mm
	PMMA	30W	2500lm	1180*43*68mm
	PMMA	36W	3000lm	1470*43*68mm
	PMMA	45W	3800lm	1760*43*68mm
	PMMA	50W	4200lm	2050*43*68mm
	PMMA	60W	5100lm	2340*43*68mm

Connectors

L 8W L 8W L 8W T 12W X 15W

Frame and accessories

continuous connector suspension wire installation buckle

Mounting Options

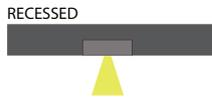

Colour Palette



Optional

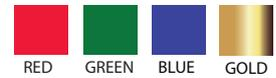

Product Image



Dimensions

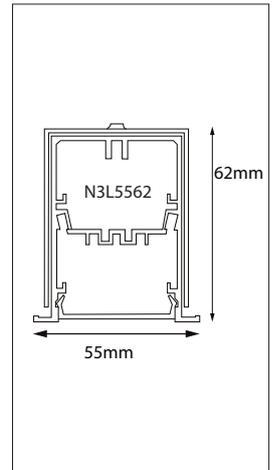

Standard Single Fittings/ Configuraciones basicas

Seamless continuous lighting system without dark spots
 Customized lighting system with our latest addition of system connection module
 Recessed mounting options available

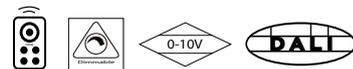

nelux CCT available correlated colour temperature



GENERAL FEATURES

Light housing made of high quality extruded aluminum Integrated with rotatable connectors at both ends makes it adjustable and uniform light output

High transmittance PMMA diffuser creating a high visual comfort and uniform lighting distributions

Light Source SMD led light source ~90lm/W and also available ~120lm/W CRI>80 as standard and available CRI90

Input voltage Multivoltage and 220-240VAC

Led Driver High Standards Led driver, dimmable as an option 1-10V, Dali and white Temperature control.

Intelligent control options , microwave sensor, daylight, wifi, bluetooth.

Mounting Options Different mounting options wall mounted, surface, recessed, suspended

No need to connect the wire, maximum 50pcs allowed to be connected for one single circuit.

Advanced thermal management technology to ensure consistency of LED life span,

color temperature and maximize output lumens

Applications Institutes, Hospitals, Warehouses, Hospitality Retail, Fake ceiling, concealed spaces .ETC

MAIN PRODUCT FEATURES

MODEL	Unit reflectors	Power	Lumens	Size
5562RC	2*10W	20W	1900lm	890*55*62mm
	3*10W	30W	2850lm	1000*55*62mm
	3*10W	30W	2850lm	1180*55*62mm
	4*10W	40W	3700lm	1000*55*62mm
	5*10W	50W	4500lm	1150*55*62mm
	5*10W	50W	4500lm	1500*55*62mm
	6*10W	60W	5400lm	2000*55*62mm

Frame and accessories

continuous connector

suspension wire

installation buckle

Mounting Options

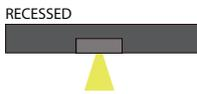

Colour Palette



Optional



Product Image



Dimensions

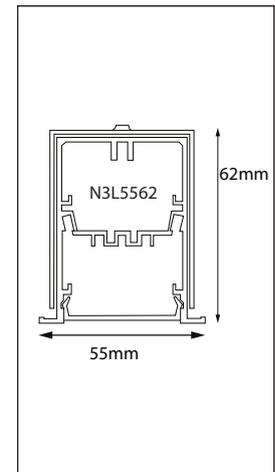

Standard Single Fittings/ Configuraciones basicas

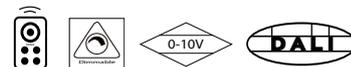

	2*10W 20W 1900lm
	3*10W 30W 2850lm
	4*10W 40W 3700lm
	5*10W 50W 4500lm
	3*10W 30W 2850lm
	9*10W 90W 8100lm
	4*10W 40W 3600lm
	5*10W 50W 4500lm

LED LINEAR LIGHT PROFILES

nelux CCT available correlated colour temperature
 6000K 4000K 3000K 2700K

GENERAL FEATURES

Light housing made of high quality extruded aluminum Integrated with rotatable connectors at both ends makes it adjustable and uniform light output

High transmittance PMMA diffuser creating a high visual comfort and uniform lighting distributions

Light Source SMD led light source ~90lm/W and also available ~120lm/W CRI>80 as standard and available CRI90

Input voltage Multivoltage and 220-240VAC

Led Driver High Standards Led driver, dimmable as an option 1-10V, Dali and white Temperature control.

Intelligent control options , microwave sensor, daylight, wifi, bluetooth.

Mounting Options Different mounting options wall mounted, surface, recessed, suspended

No need to connect the wire, maximum 50pcs allowed to be connected for one single circuit.

Advanced thermal management technology to ensure consistency of LED life span, color temperature and maximize output lumens

Applications Institutes, Hospitals, Warehouses, Hospitality Retail, Fake ceiling, concealed spaces ,ETC

MAIN PRODUCT FEATURES

MODEL	Unit reflectors	Power	Lumens	Size
5871CM	PMMA	15W	1200lm	595*43*68mm
	PMMA	20W	1700lm	890*43*68mm
	PMMA	30W	2500lm	1180*43*68mm
	PMMA	36W	3000lm	1470*43*68mm
	PMMA	45W	3800lm	1760*43*68mm
	PMMA	50W	4200lm	2050*43*68mm
	PMMA	60W	5100lm	2340*43*68mm

Connectors	PMMA diffusor
L 8W L 8W L 8W T 12W X 15W	

Frame and accessories

continuous connector	suspension wire	installation buckle

Mounting Options

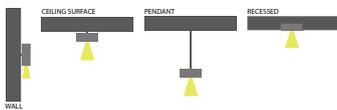

Colour Palette



Optional



Product Image



Dimensions

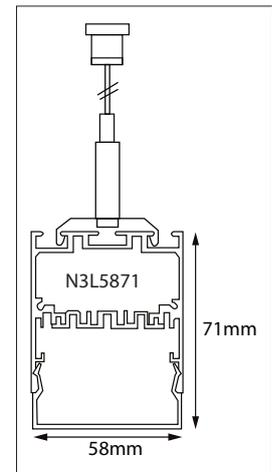

Standard Single Fittings/ Configuraciones basicas

Seamless continuous lighting system without dark spots
 Customized lighting system with our latest addition of system connection module
 Recessed mounting options available

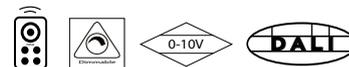

nelux CCT available correlated colour temperature



GENERAL FEATURES

Light housing made of high quality extruded aluminum Integrated with rotatable connectors at both ends makes it adjustable and uniform light output

High transmittance PMMA diffuser creating a high visual comfort and uniform lighting distributions

Light Source SMD led light source ~90lm/W and also available ~120lm/W CRI>80 as standard and available CRI90

Input voltage Multivoltage and 220-240VAC

Led Driver High Standards Led driver, dimmable as an option 1-10V, Dali and white Temperature control.

Intelligent control options , microwave sensor, daylight, wifi, bluetooth.

Mounting Options Different mounting options wall mounted, surface, recessed, suspended

No need to connect the wire, maximum 50pcs allowed to be connected for one single circuit.

Advanced thermal management technology to ensure consistency of LED life span,

color temperature and maximize output lumens

Applications Institutes, Hospitals, Warehouses, Hospitality Retail, Fake ceiling, concealed spaces ,ETC

MAIN PRODUCT FEATURES

MODEL	Unit reflectors	Power	Lumens	Size
608855	2*15W	30W	2850lm	1180*60*88mm

Frame and accessories

Mounting Options

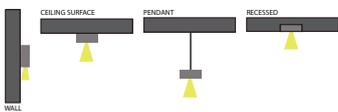

Colour Palette



Optional



Product Image



Dimensions

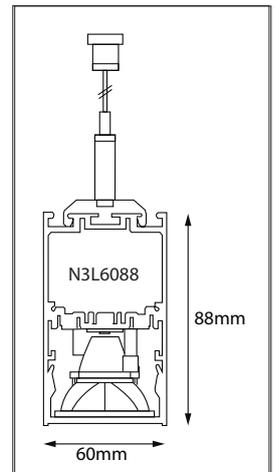

Standard Single Fittings/ Configuraciones basicas

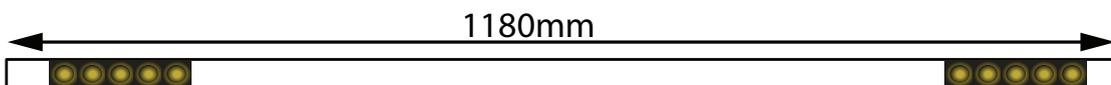
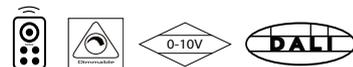

LED LINEAR LIGHT PROFILES



nelux CCT available correlated colour temperature
 6000K 4000K 3000K 2700K

GENERAL FEATURES

Light housing made of high quality extruded aluminum Integrated with rotatable connectors at both ends makes it adjustable and uniform light output

High transmittance PMMA diffuser creating a high visual comfort and uniform lighting distributions

Light Source SMD led light source ~90lm/W and also available ~120lm/W CRI>80 as standard and available CRI90

Input voltage Multivoltage and 220-240VAC

Led Driver High Standards Led driver, dimmable as an option 1-10V, Dali and white Temperature control.

Intelligent control options , microwave sensor, daylight, wifi, bluetooth.

Mounting Options Different mounting options wall mounted, surface, recessed, suspended

No need to connect the wire, maximum 50pcs allowed to be connected for one single circuit.

Advanced thermal management technology to ensure consistency of LED life span,

color temperature and maximize output lumens

Applications Institutes, Hospitals, Warehouses, Hospitality Retails, Fake ceiling, concealed spaces ,ETC

MAIN PRODUCT FEATURES

MODEL	Unit reflectors	Power	Lumens	Size
608851	10*3W	30W	2850lm	1180*60*88mm

Frame and accessories

- Trim 1 spot . Light Source XPE/XBD/3035/3535



continuous connector



suspension wire



installation buckle

Mounting Options

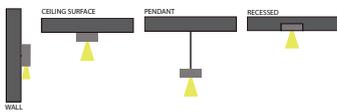

Colour Palette



Optional



Product Image



Dimensions

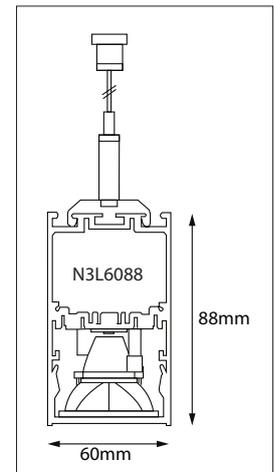

Standard Single Fittings/ Configuraciones basicas

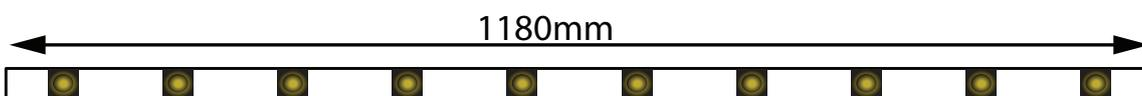
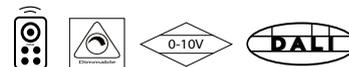

nelux CCT available correlated colour temperature



GENERAL FEATURES

Light housing made of high quality extruded aluminum Integrated with rotatable connectors at both ends makes it adjustable and uniform light output

High transmittance PMMA diffuser creating a high visual comfort and uniform lighting distributions

Light Source SMD led light source ~90lm/W and also available ~120lm/W CRI>80 as standard and available CRI90

Input voltage Multivoltage and 220-240VAC

Led Driver High Standards Led driver, dimmable as an option 1-10V, Dali and white Temperature control.

Intelligent control options , microwave sensor, daylight, wifi, bluetooth.

Mounting Options Different mounting options wall mounted, surface, recessed, suspended

No need to connect the wire, maximum 50pcs allowed to be connected for one single circuit.

Advanced thermal management technology to ensure consistency of LED life span,

color temperature and maximize output lumens

Applications Institutes, Hospitals, Warehouses, Hospitality Retail, Fake ceiling, concealed spaces ,ETC

MAIN PRODUCT FEATURES

MODEL	Unit reflectors	Power	Lumens	Size
6088G	14*3*1.5W	60W	5400lm	1180*60*88mm

Frame and accessories

GridSpot 14 spot 1.5W 60*70° . Light Source SMD 2835

continuous connector

suspension wire

installation buckle

Mounting Options

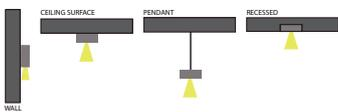

Colour Palette



Optional



Product Image



Dimensions

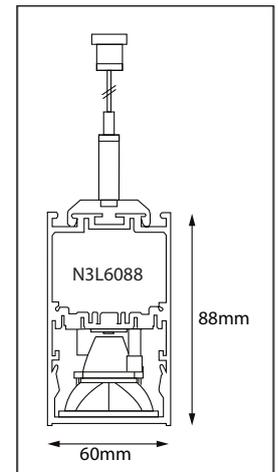

Standard Single Fittings/ Configuraciones basicas

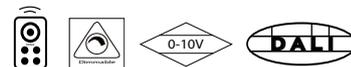

LED LINEAR LIGHT PROFILES



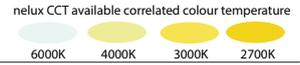

GENERAL FEATURES

Light housing made of high quality extruded aluminum Integrated with rotatable connectors at both ends makes it adjustable and uniform light output

High transmittance PMMA diffuser creating a high visual comfort and uniform lighting distributions

Light Source SMD led light source ~90lm/W and also available ~120lm/W CRI>80 as standard and available CRI90

Input voltage Multivoltage and 220-240VAC

Led Driver High Standards Led driver, dimmable as an option 1-10V, Dali and white Temperature control.

Intelligent control options , microwave sensor, daylight, wifi, bluetooth.

Mounting Options Different mounting options wall mounted, surface, recessed, suspended

No need to connect the wire, maximum 50pcs allowed to be connected for one single circuit.

Advanced thermal management technology to ensure consistency of LED life span, color temperature and maximize output lumens

Applications Institutes, Hospitals, Warehouses, Hospitality Retails, Fake ceiling, concealed spaces ,ETC

MAIN PRODUCT FEATURES

MODEL	Unit reflectors	Power	Lumens	Size
6088GS1	3*1.5W 28*1.5	50W	4500lm	1180*60*88mm

Frame and accessories

- Trim spot, beam angle 15°/30°/45°, light source XPE/XBD/3030/3035/5050
- GridSpot 14 spot 1.5W 60°70° . Light Source SMD 2835

continuous connector

suspension wire

installation buckle

Mounting Options

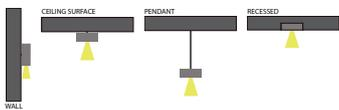

Colour Palette



Optional



Product Image

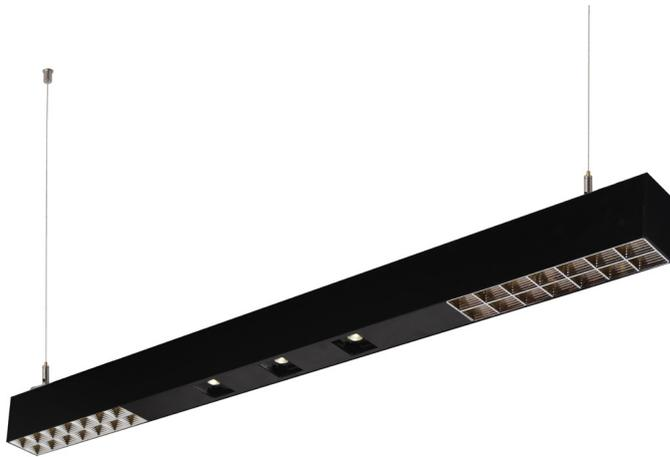

Dimensions

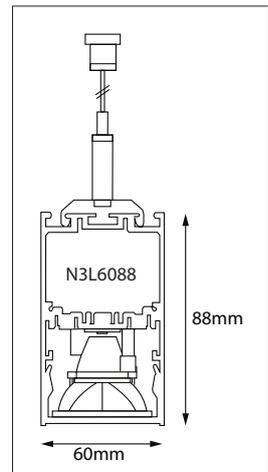

Standard Single Fittings/ Configuraciones basicas

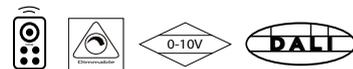

nelux CCT available correlated colour temperature



GENERAL FEATURES

Light housing made of high quality extruded aluminum Integrated with rotatable connectors at both ends makes it adjustable and uniform light output

High transmittance PMMA diffuser creating a high visual comfort and uniform lighting distributions

Light Source SMD led light source ~90lm/W and also available ~120lm/W CRI>80 as standard and available CRI90

Input voltage Multivoltage and 220-240VAC

Led Driver High Standards Led driver, dimmable as an option 1-10V, Dali and white Temperature control.

Intelligent control options , microwave sensor, daylight, wifi, bluetooth.

Mounting Options Different mounting options wall mounted, surface, recessed, suspended

No need to connect the wire, maximum 50pcs allowed to be connected for one single circuit.

Advanced thermal management technology to ensure consistency of LED life span,

color temperature and maximize output lumens

Applications Institutes, Hospitals, Warehouses, Hospitality Retail, Fake ceiling, concealed spaces ,ETC

MAIN PRODUCT FEATURES

MODEL	Unit reflectors	Power	Lumens	Size
608855PB	5*1-3W 28*1.5	50W	4500lm	1180*60*88mm

Frame and accessories

- Trim 5 spot . Light Source XPE/XBD/3035/3535
- PMMA and SMD PCB 10W 85° . Light Source SMD 2835

continuous connector suspension wire installation buckle

Mounting Options

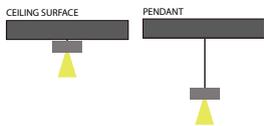

Colour Palette



Optional

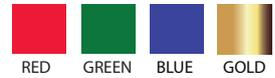

Product Image



Dimensions

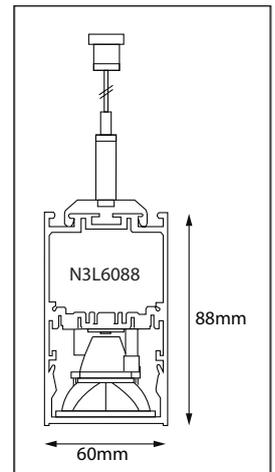

Standard Single Fittings/ Configuraciones basicas

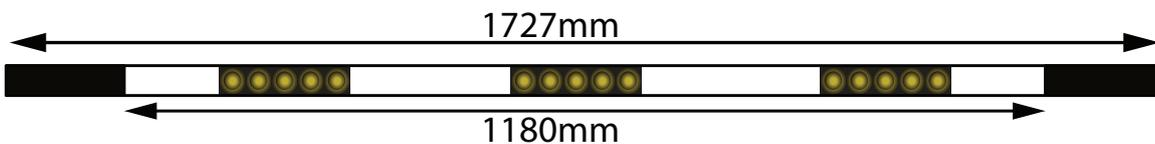
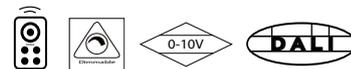

LED LINEAR LIGHT PROFILES



GENERAL FEATURES

Light housing made of high quality extruded aluminum Integrated with rotatable connectors at both ends makes it adjustable and uniform light output

High transmittance PMMA diffuser creating a high visual comfort and uniform lighting distributions

Light Source SMD led light source ~90lm/W and also available ~120lm/W CRI>80 as standard and available CRI90

Input voltage Multivoltage and 220-240VAC

Led Driver High Standards Led driver, dimmable as an option 1-10V, Dali and white Temperature control.

Intelligent control options , microwave sensor, daylight, wifi, bluetooth.

Mounting Options Different mounting options wall mounted, surface, recessed, suspended

No need to connect the wire, maximum 50pcs allowed to be connected for one single circuit.

Advanced thermal management technology to ensure consistency of LED life span, color temperature and maximize output lumens

Applications Institutes, Hospitals, Warehouses, Hospitality Retails, Fake ceiling, concealed spaces ,ETC

MAIN PRODUCT FEATURES

nelux CCT available correlated colour temperature
 6000K 4000K 3000K 2700K

MODEL	Unit reflectors	Power	Lumens	Size
6088S1PB	5*1-3W 28*1.5	50W	4500lm	1180*60*88mm

Frame and accessories

- Trim 1 spot . Light Source XPE/XBD/3035/3535
- PMMA and SMD PCB 10W 85° . Light Source SMD 2835

continuous connector suspension wire installation buckle

Mounting Options

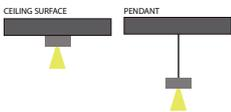

Colour Palette



Optional



Product Image



Dimensions

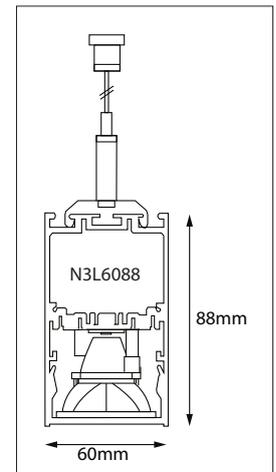

Standard Single Fittings/ Configuraciones basicas

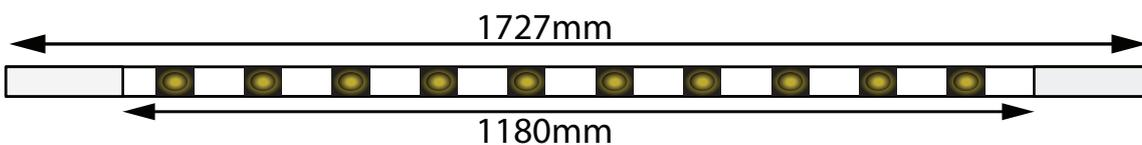
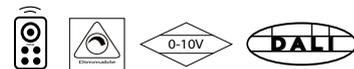

nelux CCT available correlated colour temperature



GENERAL FEATURES

Light housing made of high quality extruded aluminum Integrated with rotatable connectors at both ends makes it adjustable and uniform light output

High transmittance PMMA diffuser creating a high visual comfort and uniform lighting distributions

Light Source SMD led light source ~90lm/W and also available ~120lm/W CRI>80 as standard and available CRI90

Input voltage Multivoltage and 220-240VAC

Led Driver High Standards Led driver, dimmable as an option 1-10V, Dali and white Temperature control.

Intelligent control options , microwave sensor, daylight, wifi, bluetooth.

Mounting Options Different mounting options wall mounted, surface, recessed, suspended

No need to connect the wire, maximum 50pcs allowed to be connected for one single circuit.

Advanced thermal management technology to ensure consistency of LED life span,

color temperature and maximize output lumens

Applications Institutes, Hospitals, Warehouses, Hospitality Retail, Fake ceiling, concealed spaces .,ETC

MAIN PRODUCT FEATURES

MODEL	Unit reflectors	Power	Lumens	Size
608855P	2*5*3W +20W	50W	4100lm	1800*60*88mm

Frame and accessories

Mounting Options

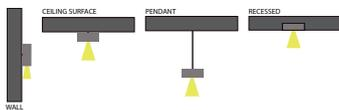

Colour Palette



Optional

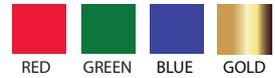

Product Image



Dimensions

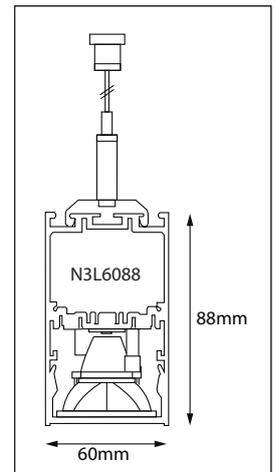

Standard Single Fittings/ Configuraciones basicas

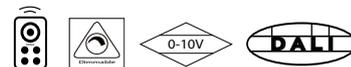

LED LINEAR LIGHT PROFILES



GENERAL FEATURES

Light housing made of high quality extruded aluminum Integrated with rotatable connectors at both ends makes it adjustable and uniform light output

High transmittance PMMA diffuser creating a high visual comfort and uniform lighting distributions

Light Source SMD led light source ~90lm/W and also available ~120lm/W CRI>80 as standard and available CRI90

Input voltage Multivoltage and 220-240VAC

Led Driver High Standards Led driver, dimmable as an option 1-10V, Dali and white Temperature control.

Intelligent control options , microwave sensor, daylight, wifi, bluetooth.

Mounting Options Different mounting options wall mounted, surface, recessed, suspended

No need to connect the wire, maximum 50pcs allowed to be connected for one single circuit.

Advanced thermal management technology to ensure consistency of LED life span, color temperature and maximize output lumens

Applications Institutes, Hospitals, Warehouses, Hospitality Retailers, Fake ceiling, concealed spaces ,ETC

MAIN PRODUCT FEATURES

nelux CCT available correlated colour temperature
 6000K 4000K 3000K 2700K

MODEL	Unit reflectors	Power	Lumens	Size
6088SQP	PMMA	60W	4800lm	1230*60*1200mm
		80W	6400lm	1520*60*1200mm

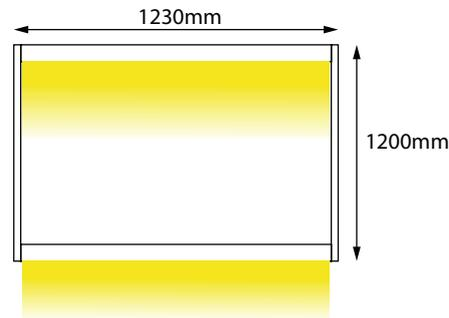

Mounting Options

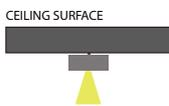

Colour Palette



Optional



Product Image



Dimensions

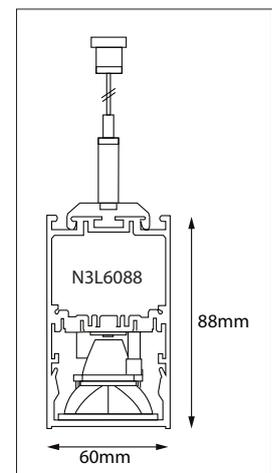

Standard Single Fittings/ Configuraciones basicas

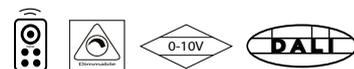

PMMA Options



10W/20W beam angle 85° SMD 2835



15W/30W beam angle 85° SMD 2835



nelux CCT available correlated colour temperature



GENERAL FEATURES

Light housing made of high quality extruded aluminum Integrated with rotatable connectors at both ends makes it adjustable and uniform light output

High transmittance PMMA diffuser creating a high visual comfort and uniform lighting distributions

Light Source SMD led light source ~90lm/W and also available ~120lm/W CRI>80 as standard and available CRI90

Input voltage Multivoltage and 220-240VAC

Led Driver High Standards Led driver, dimmable as an option 1-10V, Dali and white Temperature control.

Intelligent control options , microwave sensor, daylight, wifi, bluetooth.

Mounting Options Different mounting options wall mounted, surface, recessed, suspended

No need to connect the wire, maximum 50pcs allowed to be connected for one single circuit.

Advanced thermal management technology to ensure consistency of LED life span,

color temperature and maximize output lumens

Applications Institutes, Hospitals, Warehouses, Hospitality Retail, Fake ceiling, concealed spaces .ETC

MAIN PRODUCT FEATURES

MODEL	Unit reflectors	Power	Lumens	Size
6088CM	PMMA	15W	1200lm	595*43*68mm
	PMMA	20W	1700lm	890*43*68mm
	PMMA	30W	2500lm	1180*43*68mm
	PMMA	36W	3000lm	1470*43*68mm
	PMMA	45W	3800lm	1760*43*68mm
	PMMA	50W	4200lm	2050*43*68mm
	PMMA	60W	5100lm	2340*43*68mm

Connectors	PMMA diffuser
L 8W L 8W L 8W T 12W X 15W	

Frame and accessories

continuous connector	suspension wire	installation buckle

Mounting Options

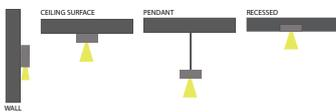

Colour Palette



Optional

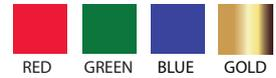

Product Image



Dimensions

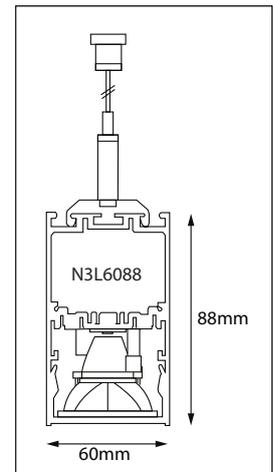

Standard Single Fittings/ Configuraciones basicas

Seamless continuous lighting system without dark spots
 Customized lighting system with our latest addition of system connection module
 Recessed mounting options available

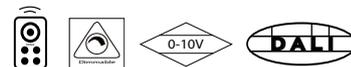

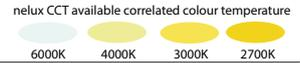

GENERAL FEATURES

Light housing made of high quality extruded aluminum Integrated with rotatable connectors at both ends makes it adjustable and uniform light output

High transmittance PMMA diffuser creating a high visual comfort and uniform lighting distributions

Light Source SMD led light source ~90lm/W and also available ~120lm/W CRI>80 as standard and available CRI90

Input voltage Multivoltage and 220-240VAC

Led Driver High Standards Led driver, dimmable as an option 1-10V, Dali and white Temperature control.

Intelligent control options, microwave sensor, daylight, wifi, bluetooth.

Mounting Options Different mounting options wall mounted, surface, recessed, suspended

No need to connect the wire, maximum 50pcs allowed to be connected for one single circuit.

Advanced thermal management technology to ensure consistency of LED life span, color temperature and maximize output lumens

Applications Institutes, Hospitals, Warehouses, Hospitality Retailers, Fake ceiling, concealed spaces ,ETC

MAIN PRODUCT FEATURES

MODEL	Unit reflectors	Power	Lumens	Size
6088CMRP	PMMA	15W	1200lm	595*43*68mm
	PMMA	20W	1700lm	890*43*68mm
	PMMA	30W	2500lm	1180*43*68mm
	PMMA	36W	3000lm	1470*43*68mm
	PMMA	45W	3800lm	1760*43*68mm
	PMMA	50W	4200lm	2050*43*68mm
	PMMA	60W	5100lm	2340*43*68mm

Connectors	PMMA diffuser
L 8W L 8W L 8W T 12W X 15W	

Frame and accessories

continuous connector	suspension wire	installation buckle

Mounting Options

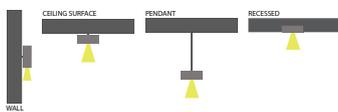

Colour Palette



Optional



Product Image



Dimensions

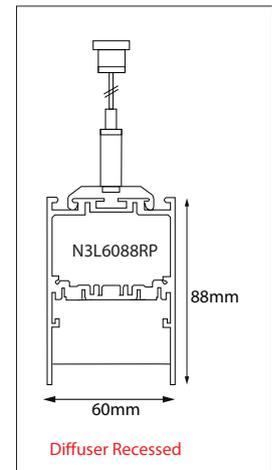

Standard Single Fittings/ Configuraciones basicas

Seamless continuous lighting system without dark spots
 Customized lighting system with our latest addition of system connection module
 Recessed mounting options available

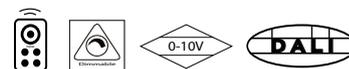

nelux CCT available correlated colour temperature



GENERAL FEATURES

Light housing made of high quality extruded aluminum Integrated with rotatable connectors at both ends makes it adjustable and uniform light output

High transmittance PMMA diffuser creating a high visual comfort and uniform lighting distributions

Light Source SMD led light source ~90lm/W and also available ~120lm/W CRI>80 as standard and available CRI90

Input voltage Multivoltage and 220-240VAC

Led Driver High Standards Led driver, dimmable as an option 1-10V, Dali and white Temperature control.

Intelligent control options , microwave sensor, daylight, wifi, bluetooth.

Mounting Options Different mounting options wall mounted, surface, recessed, suspended

No need to connect the wire, maximum 50pcs allowed to be connected for one single circuit.

Advanced thermal management technology to ensure consistency of LED life span,

color temperature and maximize output lumens

Applications Institutes, Hospitals, Warehouses, Hospitality Retails, Fake ceiling, concealed spaces ,ETC

MAIN PRODUCT FEATURES

MODEL	Unit reflectors	Power	Lumens	Size
6088CMRP	PMMA	15W	1200lm	595*43*68mm
	PMMA	20W	1700lm	890*43*68mm
	PMMA	30W	2500lm	1180*43*68mm
	PMMA	36W	3000lm	1470*43*68mm
	PMMA	45W	3800lm	1760*43*68mm
	PMMA	50W	4200lm	2050*43*68mm
	PMMA	60W	5100lm	2340*43*68mm

Connectors L 8W L 8W L 8W T 12W X 15W

PMMA diffuser

Frame and accessories

continuous connector

suspension wire

installation buckle

Mounting Options

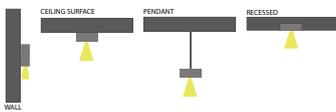

Colour Palette



Optional

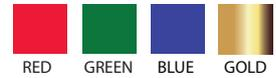

Product Image



Dimensions

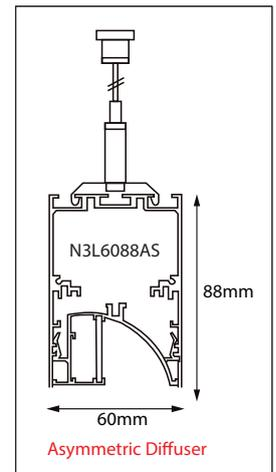

Wall Washer

Standard Single Fittings/ Configuraciones basicas

Seamless continuous lighting system without dark spots available. Asymmetric down light, to meet all kinds lighting solution, Various mounting options available

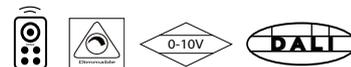

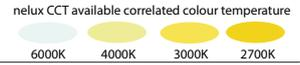

GENERAL FEATURES

Light housing made of high quality extruded aluminum Integrated with rotatable connectors at both ends makes it adjustable and uniform light output

High transmittance PMMA diffuser creating a high visual comfort and uniform lighting distributions

Light Source SMD led light source ~90lm/W and also available ~120lm/W CRI>80 as standard and available CRI90

Input voltage Multivoltage and 220-240VAC

Led Driver High Standards Led driver, dimmable as an option 1-10V, Dali and white Temperature control.

Intelligent control options , microwave sensor, daylight, wifi, bluetooth.

Mounting Options Different mounting options wall mounted, surface, recessed, suspended

No need to connect the wire, maximum 50pcs allowed to be connected for one single circuit.

Advanced thermal management technology to ensure consistency of LED life span, color temperature and maximize output lumens

Applications Institutes, Hospitals, Warehouses, Hospitality Retail, Fake ceiling, concealed spaces ,ETC

MAIN PRODUCT FEATURES

MODEL	Unit reflectors	Power	Lumens	Size
7388CMRC	PMMA	15W	1200lm	600*73*88mm
	PMMA	20W	1700lm	900*73*88mm
	PMMA	30W	2500lm	1190*73*88mm
	PMMA	36W	3000lm	1480*73*88mm
	PMMA	45W	3800lm	1770*73*88mm
	PMMA	50W	4200lm	2060*73*88mm
	PMMA	60W	5100lm	2350*73*88mm

Connectors
L 8W L 8W L 8W T 12W X 15W

Frame and accessories

continuous connector suspension wire installation buckle

Mounting Options

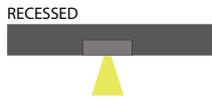

Colour Palette



Optional



Product Image



Dimensions

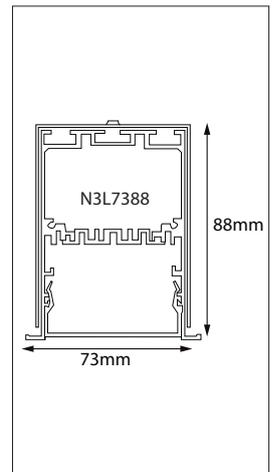

Standard Single Fittings/ Configuraciones basicas

Seamless continuous lighting system without dark spots
Customized lighting system with our latest addition of system connection module
Recessed mounting options available

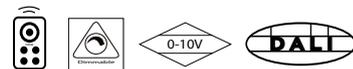

nelux CCT available correlated colour temperature



GENERAL FEATURES

Light housing made of high quality extruded aluminum Integrated with rotatable connectors at both ends makes it adjustable and uniform light output

High transmittance PMMA diffuser creating a high visual comfort and uniform lighting distributions

Light Source SMD led light source ~90lm/W and also available ~120lm/W CRI>80 as standard and available CRI90

Input voltage Multivoltage and 220-240VAC

Led Driver High Standards Led driver, dimmable as an option 1-10V, Dali and white Temperature control.

Intelligent control options , microwave sensor, daylight, wifi, bluetooth.

Mounting Options Different mounting options wall mounted, surface, recessed, suspended

No need to connect the wire, maximum 50pcs allowed to be connected for one single circuit.

Advanced thermal management technology to ensure consistency of LED life span,

color temperature and maximize output lumens

Applications Institutes, Hospitals, Warehouses, Hospitality Retail, Fake ceiling, concealed spaces ,ETC

MAIN PRODUCT FEATURES

MODEL	Unit reflectors	Power	Lumens	Size
11253CMRC	PMMA	20W	1700lm	600*112*53mm
	PMMA	30W	2500lm	900*112*53mm
	PMMA	40W	3400lm	1190*112*53mm
	PMMA	45W	3800lm	1480*112*53mm
	PMMA	55W	4600lm	1760*112*53mm
	PMMA	60W	5100lm	2060*112*53mm
	PMMA	80W	6800lm	2350*112*53mm

Connectors
L 8W L 8W L 8W T 12W X 15W

Frame and accessories

continuous connector suspension wire installation buckle

Mounting Options



Colour Palette



Optional



Product Image



Dimensions

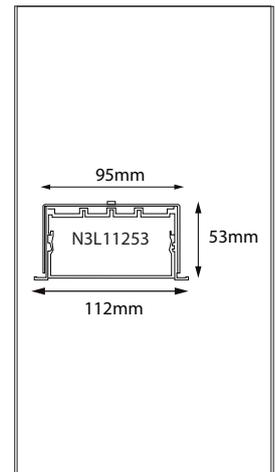

Standard Single Fittings/ Configuraciones basicas

Seamless continuous lighting system without dark spots
 Customized lighting system with our latest addition of system connection module
 Recessed mounting options available

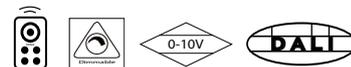

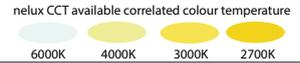

GENERAL FEATURES

Light housing made of high quality extruded aluminum Integrated with rotatable connectors at both ends makes it adjustable and uniform light output

High transmittance PMMA diffuser creating a high visual comfort and uniform lighting distributions

Light Source SMD led light source ~90lm/W and also available ~120lm/W CRI>80 as standard and available CRI90

Input voltage Multivoltage and 220-240VAC

Led Driver High Standards Led driver, dimmable as an option 1-10V, Dali and white Temperature control.

Intelligent control options , microwave sensor, daylight, wifi, bluetooth.

Mounting Options Different mounting options wall mounted, surface, recessed, suspended

No need to connect the wire, maximum 50pcs allowed to be connected for one single circuit.

Advanced thermal management technology to ensure consistency of LED life span, color temperature and maximize output lumens

Applications Institutes, Hospitals, Warehouses, Hospitality Retails, Fake ceiling, concealed spaces ,ETC

MAIN PRODUCT FEATURES

MODEL	Unit reflectors	Power	Lumens	Size
4313655	3*10	30W	4800lm	1180*43*136mm
	4*10	40W	6400lm	1470*43*136mm
	6*10	60W	8400lm	1760*43*136mm

Frame and accessories

Mounting Options

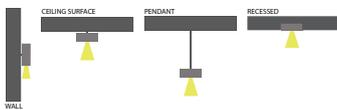

Colour Palette



Optional



Product Image



Dimensions

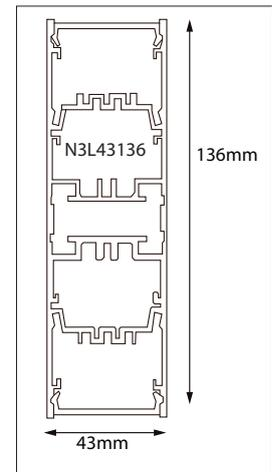

Standard Single Fittings/ Configuraciones basicas

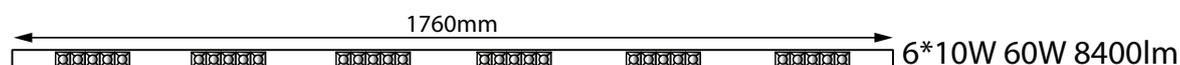
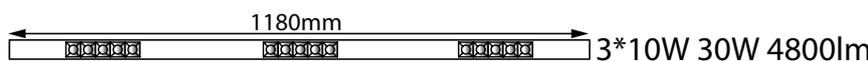
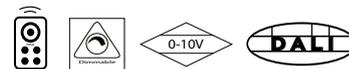

nelux CCT available correlated colour temperature



GENERAL FEATURES

Light housing made of high quality extruded aluminum Integrated with rotatable connectors at both ends makes it adjustable and uniform light output

High transmittance PMMA diffuser creating a high visual comfort and uniform lighting distributions

Light Source SMD led light source ~90lm/W and also available ~120lm/W CRI>80 as standard and available CRI90

Input voltage Multivoltage and 220-240VAC

Led Driver High Standards Led driver, dimmable as an option 1-10V, Dali and white Temperature control.

Intelligent control options , microwave sensor, daylight, wifi, bluetooth.

Mounting Options Different mounting options wall mounted, surface, recessed, suspended

No need to connect the wire, maximum 50pcs allowed to be connected for one single circuit.

Advanced thermal management technology to ensure consistency of LED life span,

color temperature and maximize output lumens

Applications Institutes, Hospitals, Warehouses, Hospitality Retail, Fake ceiling, concealed spaces ,ETC

MAIN PRODUCT FEATURES

MODEL	Unit reflectors	Power	Lumens	Size
43136S1	10*2W	20W	1900lm	600*43*136mm
	20*1.5W	30W	2850lm	1000*43*136mm
	20*1.5W	30W	2850lm	1180*43*136mm
	20*2W	40W	3700lm	1180*43*136mm
	40*1.5W	60W	5700lm	2000*43*136mm
	40*2W	80W	7400lm	2000*43*136mm
	40*1.5W	60W	5700lm	2350*43*136mm
	40*2W	80W	7400lm	2350*43*136mm

Frame and accessories

- Trim 1 spot . Light Source XPE/XBD/3035/3535

continuous connector

suspension wire

installation buckle

Mounting Options

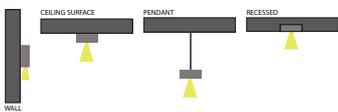

Colour Palette



Optional

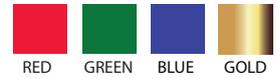

Product Image

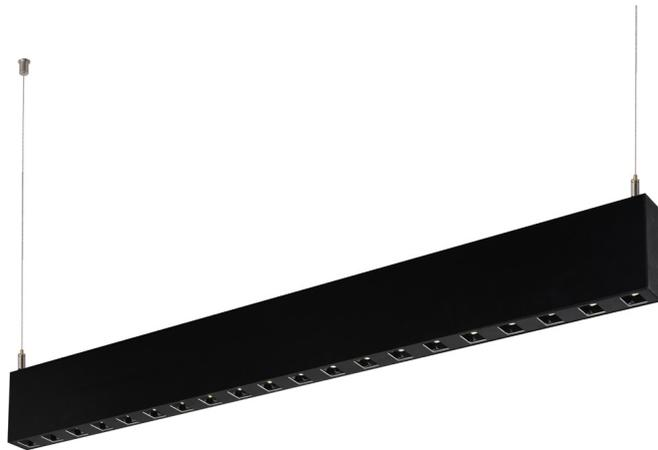

Dimensions

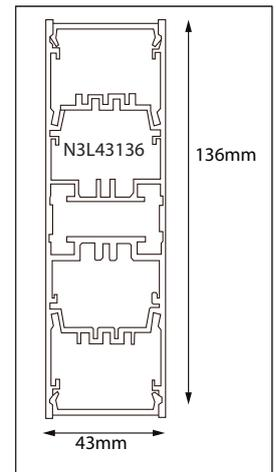

Standard Single Fittings/ Configuraciones basicas

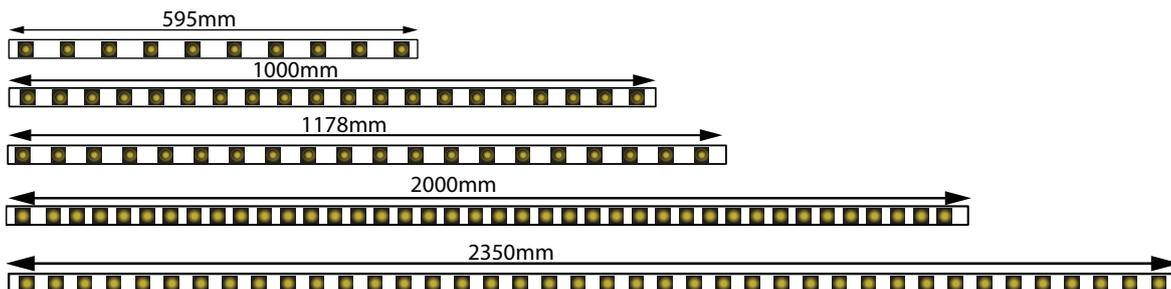
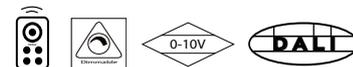

LED LINEAR LIGHT PROFILES



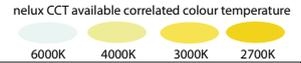

GENERAL FEATURES

Light housing made of high quality extruded aluminum Integrated with rotatable connectors at both ends makes it adjustable and uniform light output

High transmittance PMMA diffuser creating a high visual comfort and uniform lighting distributions

Light Source SMD led light source ~90lm/W and also available ~120lm/W CRI>80 as standard and available CRI90

Input voltage Multivoltage and 220-240VAC

Led Driver High Standards Led driver, dimmable as an option 1-10V, Dali and white Temperature control.

Intelligent control options , microwave sensor, daylight, wifi, bluetooth.

Mounting Options Different mounting options wall mounted, surface, recessed, suspended

No need to connect the wire, maximum 50pcs allowed to be connected for one single circuit.

Advanced thermal management technology to ensure consistency of LED life span, color temperature and maximize output lumens

Applications Institutes, Hospitals, Warehouses, Hospitality Retailers, Fake ceiling, concealed spaces ,ETC

MAIN PRODUCT FEATURES

MODEL	Reflector	Power	Lumens	Size
43136UD	PMMA	15W+15W	1200+1200lm	595*43*136mm
	PMMA	15W+20W	1200+1700lm	890*43*136mm
	PMMA	15W+30W	1200+2500lm	1180*43*136mm
	PMMA	20W+36W	1700+3000lm	1470*43*136mm
	PMMA	25W+45W	2100+3800lm	1760*43*136mm
	PMMA	30W+50W	2500+4200lm	2050*43*136mm
	PMMA	36W+60W	3000+5100lm	2340*43*136mm

Frame and accessories

PMMA up and down . Light Source SMD 2835



Mounting Options

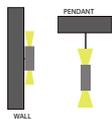

Colour Palette



Optional

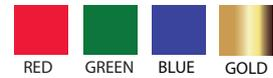

Product Image



Dimensions

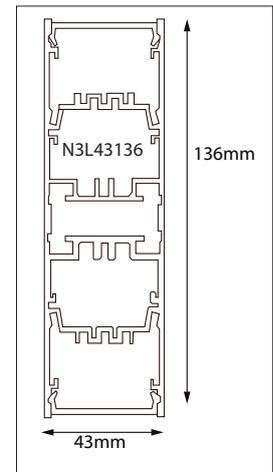

Standard Single Fittings/ Configuraciones basicas

Seamless continuous lighting system without dark spots available. Up &down light ,to meet all kinds lighting solution

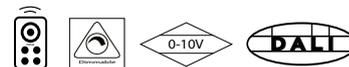

GENERAL FEATURES

Light housing made of high quality extruded aluminum Integrated with rotatable connectors at both ends makes it adjustable and uniform light output

High transmittance PMMA diffuser creating a high visual comfort and uniform lighting distributions

Light Source SMD led light source ~90lm/W and also available ~120lm/W CRI>80 as standard and available CRI90

Input voltage Multivoltage and 220-240VAC

Led Driver High Standards Led driver, dimmable as an option 1-10V, Dali and white Temperature control.

Intelligent control options , microwave sensor, daylight, wifi, bluetooth.

Mounting Options Different mounting options wall mounted, surface, recessed, suspended

No need to connect the wire, maximum 50pcs allowed to be connected for one single circuit.

Advanced thermal management technology to ensure consistency of LED life span,

color temperature and maximize output lumens

Applications Institutes, Hospitals, Warehouses, Hospitality Retail, Fake ceiling, concealed spaces ,ETC

MAIN PRODUCT FEATURES

nelux CCT available correlated colour temperature



MODEL	Unit reflectors	Power	Lumens	Size
75102CM	PMMA	15W	1200lm	600*75*102mm
	PMMA	20W	1700lm	890*75*102mm
	PMMA	30W	2500lm	1180*75*102mm
	PMMA	36W	3000lm	1470*75*102mm
	PMMA	45W	3800lm	1760*75*102mm
	PMMA	50W	4200lm	2050*75*102mm
	PMMA	60W	5100lm	2340*75*102mm

Connectors	PMMA diffusor
L 8W L 8W L 8W T 12W X 15W	

Frame and accessories		
continuous connector	suspension wire	installation buckle

Mounting Options

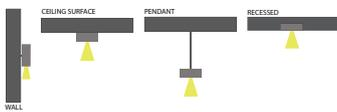

Colour Palette



Optional



Product Image



Dimensions

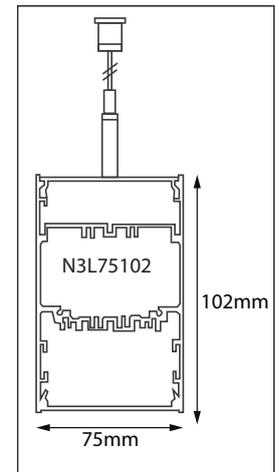

Standard Single Fittings/ Configuraciones basicas

Seamless continuous lighting system without dark spots
 Customized lighting system with our latest addition of system connection module
 Recessed mounting options available

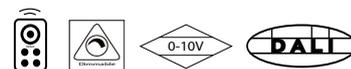

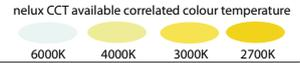

GENERAL FEATURES

Light housing made of high quality extruded aluminum Integrated with rotatable connectors at both ends makes it adjustable and uniform light output

High transmittance PMMA diffuser creating a high visual comfort and uniform lighting distributions

Light Source SMD led light source ~90lm/W and also available ~120lm/W CRI>80 as standard and available CRI90

Input voltage Multivoltage and 220-240VAC

Led Driver High Standards Led driver, dimmable as an option 1-10V, Dali and white Temperature control.

Intelligent control options , microwave sensor, daylight, wifi, bluetooth.

Mounting Options Different mounting options wall mounted, surface, recessed, suspended

No need to connect the wire, maximum 50pcs allowed to be connected for one single circuit.

Advanced thermal management technology to ensure consistency of LED life span, color temperature and maximize output lumens

Applications Institutes, Hospitals, Warehouses, Hospitality Retail, Fake ceiling, concealed spaces ,ETC

MAIN PRODUCT FEATURES

MODEL	Reflector	Power	Lumens	Size
75102CMUD	PMMA	15W+15W	1200+1200lm	600*75*102mm
	PMMA	15W+20W	1200+1700lm	890*75*102mm
	PMMA	15W+30W	1200+2500lm	1180*75*102mm
	PMMA	20W+36W	1700+3000lm	1470*75*102mm
	PMMA	25W+45W	2100+3800lm	1760*75*102mm
	PMMA	30W+50W	2500+4200lm	2050*75*102mm
	PMMA	36W+60W	3000+5100lm	2340*75*102mm

Connectors and PMMA	
L 8W L 8W L 8W T 12W X 15W	PMMA

Pendant and Union Accessories		
continuous connector	suspension wire	installation buckle

Mounting Options

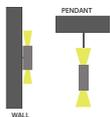

Colour Palette



Optional



Product Image



Dimensions

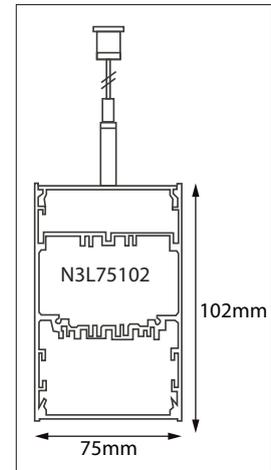

Standard Single Fittings/ Configuraciones basicas

Seamless continuous lighting system without dark spots
 Customized lighting system with our latest addition of system connection module
 Recessed mounting options available

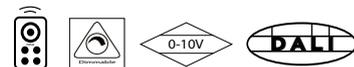

nelux CCT available correlated colour temperature



GENERAL FEATURES

Light housing made of high quality extruded aluminum Integrated with rotatable connectors at both ends makes it adjustable and uniform light output

High transmittance PMMA diffuser creating a high visual comfort and uniform lighting distributions

Light Source SMD led light source ~90lm/W and also available ~120lm/W CRI>80 as standard and available CRI90

Input voltage Multivoltage and 220-240VAC

Led Driver High Standards Led driver, dimmable as an option 1-10V, Dali and white Temperature control.

Intelligent control options , microwave sensor, daylight, wifi, bluetooth.

Mounting Options Different mounting options wall mounted, surface, recessed, suspended

No need to connect the wire, maximum 50pcs allowed to be connected for one single circuit.

Advanced thermal management technology to ensure consistency of LED life span,

color temperature and maximize output lumens

Applications Institutes, Hospitals, Warehouses, Hospitality Retail, Fake ceiling, concealed spaces ,ETC

MAIN PRODUCT FEATURES

MODEL	Unit reflectors	Power	Lumens	Size
93106CM	PMMA	20W	1700lm	600*93*106mm
	PMMA	30W	2500lm	890*93*106mm
	PMMA	40W	3400lm	1180*93*106mm
	PMMA	45W	3800lm	1470*93*106mm
	PMMA	55W	4600lm	1760*93*106mm
	PMMA	60W	5100lm	2050*93*106mm
	PMMA	80W	6800lm	2340*93*106mm

Connectors		PMMA diffuser
L 8W	L 8W L 8W T 12W X 15W	

Frame and accessories		
continuous connector	suspension wire	installation buckle

Mounting Options

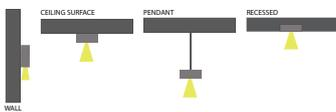

Colour Palette



Optional



Product Image



Dimensions

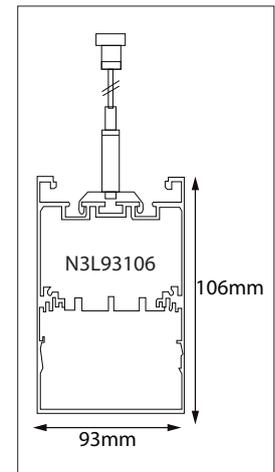

Standard Single Fittings/ Configuraciones basicas

Seamless continuous lighting system without dark spots
 Customized lighting system with our latest addition of system connection module
 Recessed mounting options available

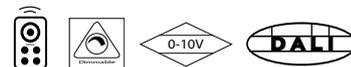

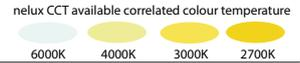

GENERAL FEATURES

Light housing made of high quality extruded aluminum Integrated with rotatable connectors at both ends makes it adjustable and uniform light output

High transmittance PMMA diffuser creating a high visual comfort and uniform lighting distributions

Light Source SMD led light source ~90lm/W and also available ~120lm/W CRI>80 as standard and available CRI90

Input voltage Multivoltage and 220-240VAC

Led Driver High Standards Led driver, dimmable as an option 1-10V, Dali and white Temperature control.

Intelligent control options , microwave sensor, daylight, wifi, bluetooth.

Mounting Options Different mounting options wall mounted, surface, recessed, suspended

No need to connect the wire, maximum 50pcs allowed to be connected for one single circuit.

Advanced thermal management technology to ensure consistency of LED life span, color temperature and maximize output lumens

Applications Institutes, Hospitals, Warehouses, Hospitality Retailers, Fake ceiling, concealed spaces ,ETC

MAIN PRODUCT FEATURES

MODEL	Unit reflectors	Power	Lumens	Size
95106CM	PMMA	20W	1700lm	600*93*106mm
	PMMA	30W	2500lm	890*93*106mm
	PMMA	40W	3400lm	1180*93*106mm
	PMMA	45W	3800lm	1470*93*106mm
	PMMA	55W	4600lm	1760*93*106mm
	PMMA	60W	5100lm	2050*93*106mm
	PMMA	80W	6800lm	2340*93*106mm

Connectors	PMMA diffusor
L 8W L 8W L 8W T 12W X 15W	

Frame and accessories

continuous connector	suspension wire	installation buckle

Mounting Options

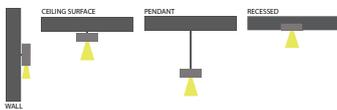

Colour Palette



Optional



Product Image



Dimensions

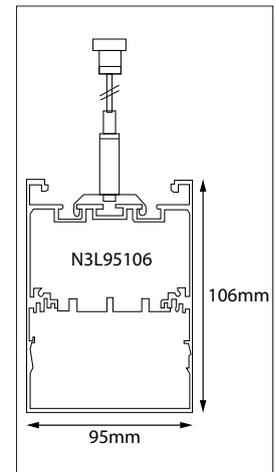

Standard Single Fittings/ Configuraciones basicas

Seamless continuous lighting system without dark spots
 Customized lighting system with our latest addition of system connection module
 Recessed mounting options available

